



Bifurcations and Dynamic Complexity in Simple Ecological Models

Robert M. May; George F. Oster

American Naturalist, Volume 110, Issue 974 (Jul. - Aug., 1976), 573-599.

Stable URL:

<http://links.jstor.org/sici?sici=0003-0147%28197607%2F08%29110%3A974%3C573%3ABADCIS%3E2.0.CO%3B2-W>

Your use of the JSTOR archive indicates your acceptance of JSTOR's Terms and Conditions of Use, available at <http://www.jstor.org/about/terms.html>. JSTOR's Terms and Conditions of Use provides, in part, that unless you have obtained prior permission, you may not download an entire issue of a journal or multiple copies of articles, and you may use content in the JSTOR archive only for your personal, non-commercial use.

Each copy of any part of a JSTOR transmission must contain the same copyright notice that appears on the screen or printed page of such transmission.

American Naturalist is published by The University of Chicago Press. Please contact the publisher for further permissions regarding the use of this work. Publisher contact information may be obtained at <http://www.jstor.org/journals/ucpress.html>.

American Naturalist

©1976 The University of Chicago Press

JSTOR and the JSTOR logo are trademarks of JSTOR, and are Registered in the U.S. Patent and Trademark Office. For more information on JSTOR contact jstor-info@umich.edu.

©2003 JSTOR

BIFURCATIONS AND DYNAMIC COMPLEXITY IN
SIMPLE ECOLOGICAL MODELS

ROBERT M. MAY AND GEORGE F. OSTER

Biology Department, Princeton University, Princeton, New Jersey 08540; and
Department of Entomology, University of California, Berkeley, California 94720.

Nature is complex. Despite this acknowledged fact, there is a rationale for constructing oversimplified mathematical caricatures of reality: one hopes to capture the essence of observed patterns and processes without becoming enmeshed in the details. This strategy has enjoyed considerable success in physics and chemistry, and there is a growing literature exploring simple mathematical models in ecology and debating their usefulness.

It is not our aim to contribute to this debate, as such. Rather we wish to point out a disconcerting property of many very simple, deterministic models which allows them to behave in extremely complicated ways.

That simple models can do complicated things is not a new idea: Poincaré expressed despair of ever completely understanding the motions of even trivial mechanical systems. Nevertheless, there is still a tendency on the part of most ecologists to interpret apparently erratic data as either stochastic “noise” or random experimental error. There is, however, a third alternative, namely, that wide classes of deterministic models can give rise to apparently chaotic dynamical behavior. It is this third possibility which we elaborate in this paper.

Although the mathematical underpinnings of the subjects we shall discuss are still rather esoteric by current standards in ecology, the central notions are elementary and can be illustrated by simple examples. Therefore we shall focus on pictorial representations and qualitative arguments. Proofs will either be set out in appendices (when our material is new) or be found in other cited sources. Our aim is to alert would-be modelers in ecology to the snake-in-the-mathematical-grass called “bifurcations” and to the subtle and disturbing consequences it can have for the relation between ecological theory and experiment.

In Section I we show how the dynamical behavior of many simple difference equations goes from a stable point, through a sequence of bifurcations, into stable cycles of period 2, 4, 8, . . . , and finally into a regime of apparent chaos. This is illustrated with a particular example, but the emphasis is on the generic character of the process. Section II develops some of the ecological implications of the phenomenon; this section is of central importance. Section III notes briefly that in practice there will ultimately be a fourth regime of behavior,

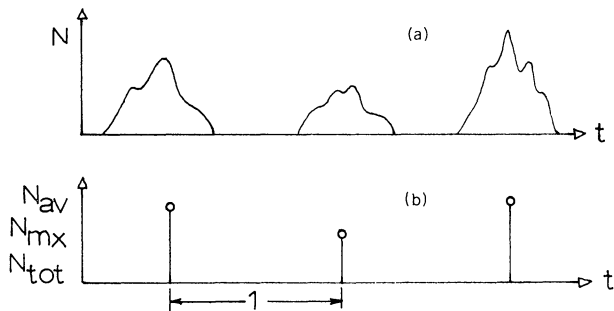

FIG. 1.—For a periodically breeding organism with nonoverlapping generations, the magnitude of the maximum, average, or total population per generation can be represented by a difference equation of the form $N_{t+1} = F(N_t)$.

namely, certain extinction. Section IV reviews a variety of other studies (largely numerical) of complicated bifurcation phenomena. Our discussion focusses mainly on discrete generation difference equation models, but Section IV makes it clear that the general phenomenon is characteristic of continuous time models as well (Oster and Guckenheimer 1976), although here the mathematical results are considerably more meager. The main results are summarized, and some biological and mathematical morals drawn, in Section V.

Some of the basic ideas set out in Section I have been outlined very briefly in an earlier report (May 1974*a*), and some of the detailed behavior of equations 1 and 2 of table 1 have been explored by Li and Yorke (1975) and by May (1975). The significance of the present work is its emphasis on generic properties, the discussion in Sections II and III, the review in Section IV, and the new mathematical results incorporated in the two appendices.

I. BIFURCATIONS IN SIMPLE DIFFERENCE EQUATIONS

Preliminaries

One of the simplest population systems is a seasonally breeding organism whose generations do not overlap. The population history may look something like figure 1*a*. If we are interested only in the maximum, the average, or the total annual population, we might consider describing the population by a difference equation of the form

$$N_{t+1} = F(N_t). \quad (1)$$

That is, we replace the continuously varying population by a stroboscopic snapshot at yearly intervals (fig. 1*b*).

A number of such models have been employed in ecology, especially in the entomological literature. A number of equations of this type are collected in table 1. They all share the following qualitative features: (1) They are homogeneous, i.e., $F(N) = Nf(N)$, so that if the population vanishes 1 yr, it will remain zero forever after. (2) They often have a critical point, $dF/dN = 0$,

TABLE 1
 SOME DIFFERENCE EQUATIONS, TAKEN FROM BIOLOGICAL LITERATURE,
 WHICH CAN EXHIBIT BIFURCATION PHENOMENA

Equation No.	$F(N)$ (See Eq. [1])	Source
1.....	$N \exp [r(1 - N/K)]$	Moran 1950; Ricker 1954; Macfadyen 1963; Cook 1965; May 1974b
2.....	$N[1 + r(1 - N/K)]$	Maynard Smith 1968, 1974; May 1972; Krebs 1972; Li and Yorke 1975; Chaundy and Phillips 1936
3.....	$\frac{\lambda N}{1 + \exp [-A(1 - N/B)]}$	Pennycuik et al. 1968; Usher 1972; Beddington 1974
4.....	$\lambda N(1 + aN)^{-b}$	Hassell 1974; Hassell et al. 1976
5.....	$\frac{\lambda N}{1 + (N/B)^b}$	Maynard Smith 1974; $b = 1$, Leslie 1957; $b = 1$, Skellam 1951; $b = 1$, Utida 1967
6.....	λN ; if $N < C$ λN^{1-b} ; if $N > C$	Varley et al. 1973 (and references therein)
7.....	$\lambda_+ N$; if $N < K$ $\lambda_- N$; if $N > K$	Williamson 1974, with $\lambda_+ > 1$ and $\lambda_- < 1$
8.....	$N[1/(a + bN) - \sigma]$	Utida 1957
9.....	$N \phi(N)$	$\phi(N)$ obtained explicitly from experiments on flies by Nicholson and others (see Oster et al. 1976)

for some $N = N_0 > 0$. This is a reflection of the delayed density dependence of the population growth: as N increases, eventually the birth rate decreases and/or the death rate increases; the ‘‘hump’’ in $F(N)$ implies that this density dependence has a sufficient time lag so as to produce an overshoot of the equilibrium. (3) They contain adjustable parameters which affect the shape of the curve $F(N)$. These parameters represent, *inter alia*, the net reproductive rate of the population, which may change from year to year.

Note that if F has a critical point, it cannot be viewed merely as a finite version of an ordinary differential equation. A one-dimensional differential equation system cannot overshoot its equilibrium nor oscillate about it.

If we fix the parameters, then we can plot N_{t+1} versus N_t and obtain a graph of the function $F(N)$, as shown in figure 2a. The intersections of $F(N)$ with the line $N_{t+1} = N_t$, the 45° bisector, yield the possible steady states, or equilibrium points (or, in mathematical language, ‘‘fixed points’’), N^* .

It is easy to plot out the time course of the population by generating the sequence of points N_0, N_1, \dots , as shown in figure 2b.

If the orbit is started near the fixed point (steady state),

$$N^* = F(N^*), \tag{2}$$

then whether or not the trajectory converges to the equilibrium depends on the eigenvalues of F at N^* (see, e.g., May 1972). In the one-dimensional case we are discussing here, the eigenvalue of F at N^* is just the slope of F at its intersection with the 45° line, $(dF/dN)_{N=N^*}$. This is shown in figure 3, where we denote the eigenvalue at the equilibrium by $\lambda(\alpha)$ to emphasize the fact that the

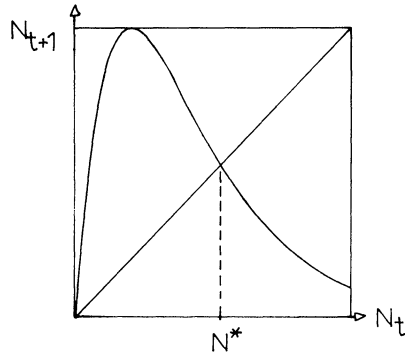

(a)

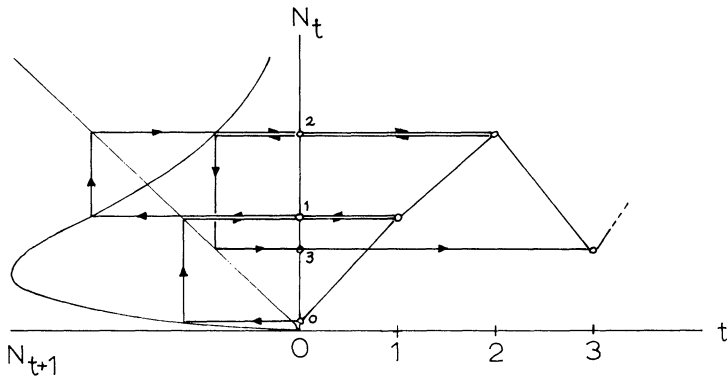

(b)

FIG. 2.—*a*, A typical form for $F(N)$. The presence of a critical point, $dF/dN = 0$ (a “hump”), indicates that there is a density dependence sufficiently delayed so as to produce an “overshoot” of the equilibrium at N^* . *b*, Plotting the time course generated by $N_{t+1} = F(N_t)$: (1) Turn the graph of F on its side so that the N_t axis coincides with the axis of the time plot. (2) Start at N_0 and go horizontally to the graph of $F(N)$. (3) Go vertically to the 45° line and horizontally to the N_t axis. This is N_1 . Extend the line to the time point $t = 1$. (4) Repeat the process starting at N_1 .

slope of F depends on the value(s) of the parameter(s), α , in F . As figure 3 illustrates,¹ if the slope of F at N^* lies between 45° and -45° , then $|\lambda(\alpha)| < 1$, and the fixed point is locally “attracting” (with monotonic damping for slopes

¹ This geometrical way of relating the stability of the fixed point to the slope of $F(N)$ at its intersection with the 45° line has been developed independently by Samuelson (1942), Ricker (1954), and Moran (1950) (for succinct reviews, see Varley et al. [1973], Clark [1976], Williamson [1972], or Baumol [1970]). A more algebraic discussion, which aims to relate the stability character of the fixed point to the underlying biology, is given by May et al. (1974). In Appendix C the above graphical construction is generalized to the case of time-dependent equations.

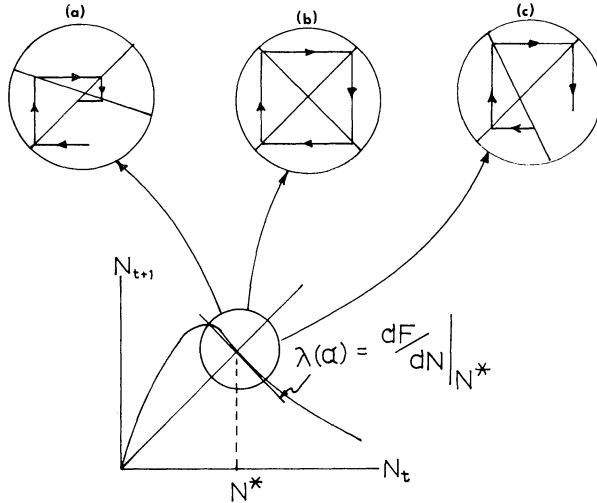

FIG. 3.—The eigenvalue (slope) at N^* determines the local stability of the fixed point $F(N) = N$: (a) $|\lambda(\alpha)| < 1$: the fixed point is an “attractor,” (b) $|\lambda(\alpha)| = 1$: the fixed point is “neutrally stable,” (c) $|\lambda(\alpha)| > 1$: the fixed point is a “repellor.”

between 45° and 0° , and oscillatory damping for slopes between 0° and -45° . As the slope steepens beyond -45° , then $|\lambda(\alpha)| > 1$, and the fixed point becomes repelling.

We now focus attention upon what happens to the stability of the fixed point, and to the dynamical trajectory generated by F , as the parameters are changed, corresponding to a progressively increasing reproductive rate (or “biotic potential”).

Bifurcations: An Example

To illustrate what happens when the parameters in F change, we use the one-parameter model 1 of table 1:

$$\begin{aligned}
 X_{t+1} &= X_t \exp [r(1 - X_t)] \\
 &\equiv F(X_t; r).
 \end{aligned}
 \tag{3}$$

Here we have for notational convenience defined $X_t \equiv N_t/K$. Figure 4 shows $F(X; r)$ for several values of r .

Although we use this particular example in order to give a detailed analysis, we emphasize that the general character of the dynamical behavior we shall describe is *not* specific to this model, but rather is generic to any curve with a hump whose steepness can be parametrically tuned. That is, our analysis will depend, in its essentials, only on the general shape of the function $F(N)$.

The fixed point of equation (3) is at $X^* = 1$, and the slope of $F(X; r)$ at X^* is $\lambda(r) = 1 - r$. Thus the equilibrium is stable if $0 < r < 2$. However, as r increases past 2, the fixed point changes from an attractor to a repellor.

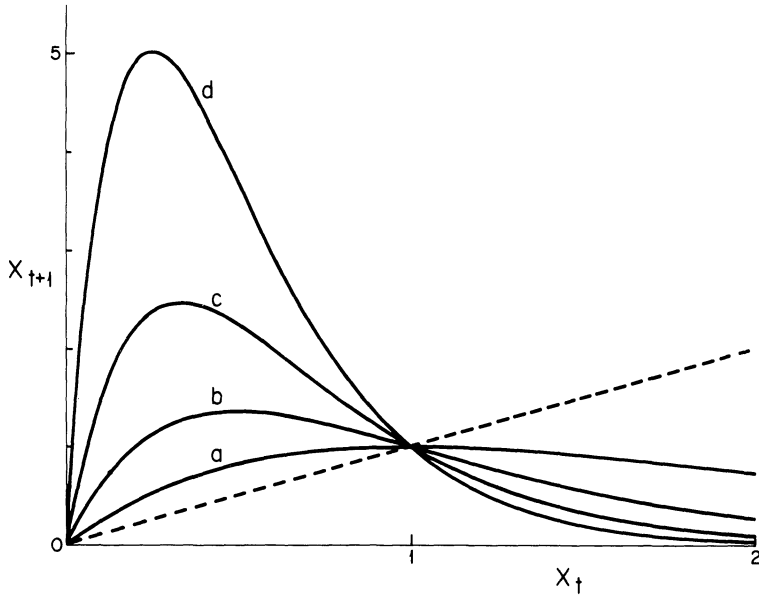

FIG. 4.—The equation $X_{t+1} = X_t \exp [r(1 - X_t)]$ for various values of r : a , $r = 1$; b , $r = 2$; c , $r = 3$; d , $r = 4$.

To see what is happening, we examine the relation between X_t and X_{t+2} :

$$X_{t+2} = F^{(2)}(X_t; r), \quad (4)$$

where

$$F^{(2)}(X) \equiv F[F(X)]. \quad (5)$$

We now examine the fixed points of period 2, $X^{*(2)}$; that is, those points which are invariant under two iterations of the map F . These points can be located either by solving the appropriate algebraic equation,

$$X^{*(2)} = F^{(2)}[X^{*(2)}], \quad (6)$$

or by graphically iterating F as shown in figure 5.

We see that if F has one hump (one critical point), then $F^{(2)}$ will have two humps (two critical points). However, if $r < 2$ (i.e., the fixed point of F is stable), then $F^{(2)}$ will only intersect the 45° line once, as shown in figure 6a. At $r = 2$, $F^{(2)}$ is tangent to the 45° line, and the fixed point is "neutrally stable": small oscillations about it will persist undamped. When $r > 2$, $F^{(2)}$ begins to develop a "loop," intersecting the 45° line in three points. As r increases past 2, the original fixed point becomes unstable and splits into two new fixed points, $X_1^{*(2)}$ and $X_2^{*(2)}$, which move apart as the loop in $F^{(2)}$ becomes larger with increasing r . These new points are initially stable, since the eigenvalue (slope) of $F^{(2)}$ at these points has magnitude less than unity. These stable oscillations of period 2, which alternate between $X_1^{*(2)}$ and $X_2^{*(2)}$, are illustrated in figure 7.

As r continues to increase, the humps of $F^{(2)}$ become steeper, and the slopes at $X_1^{*(2)}$ and $X_2^{*(2)}$ increase until the period 2 points in turn become unstable,

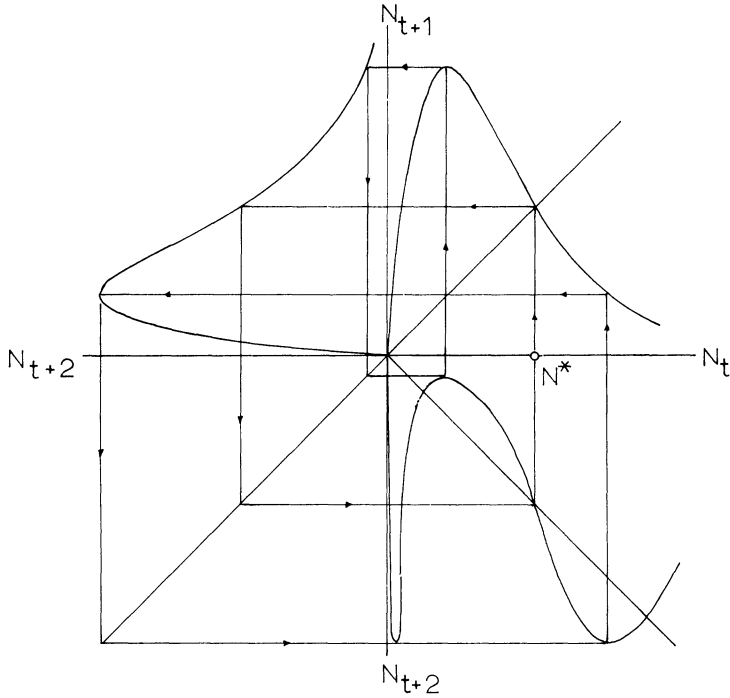

FIG. 5.—To compose F with itself, turn F on its side so that the ordinates and abscissas correspond. Then follow the arrows as shown to generate the graph of F^2 . We see that graphically composing the one-hump map, F , with itself yields the two-hump map F^2 . If $r > 2$, F^2 has three fixed points.

when $\lambda^{(2)}[X_i^{*(2)}] \equiv [dF^{(2)}/dX]_{X=X_i^{*(2)}} < -1$. Then they too bifurcate, splitting into pairs of attracting fixed points of period 4. This can be easily seen by graphically composing $F^{(2)}$ with itself.

If we continue to increase r , the same process will repeat itself. The graph of $F^{(k)}$ when composed with itself will give rise to a graph of $F^{(2k)}$ which develops kinks. As the points of period k become unstable [which happens when the slope of the intercept of the $F^{(k)}$ graph on the 45° line, $\lambda^{(k)}$, steepens beyond -45°], the kinks in $F^{(2k)}$ grow so as to loop through the 45° line, corresponding

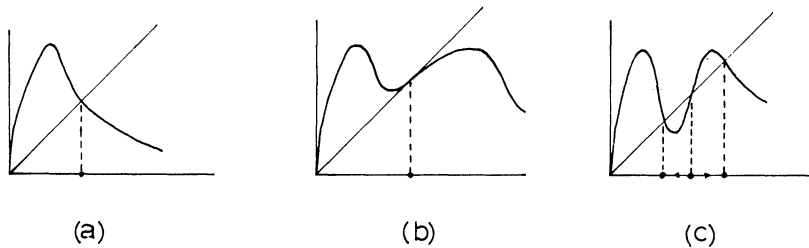

FIG. 6.—*a*, $r < 2$: original fixed point is stable; *b*, $r = 2$: original fixed point bifurcates; *c*, $r > 2$: two period-2 attracting fixed points emerge from the original fixed point which is now a repeller.

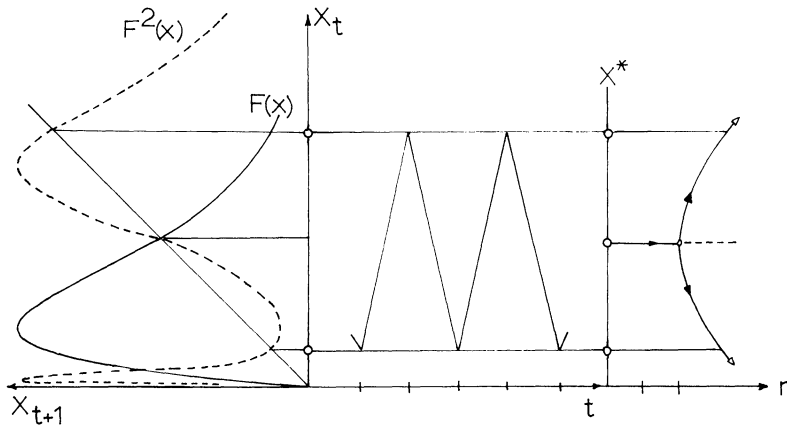

FIG. 7.—When $|\lambda(x)| < 1$, ($r < 2$), the difference eq. (3) is stable about $X^* = 1$. The fixed point becomes unstable and splits into two stable period-2 points as $\lambda(r)$ increases past 1. The two new fixed points move further apart as r is increased, until the next bifurcation occurs.

to the period k points bifurcating into pairs of fixed points with period $2k$ [whose stability depends on the eigenvalues, $\lambda^{(2k)}$, of $F^{(2k)}$].

This process can be drawn on a “branching diagram” by plotting the fixed points versus r , as shown to the right in figure 7. A more complete picture of the way increasing r gives rise to a hierarchy of bifurcating stable points of period 1, 2, 4, 8, 16, . . . , is given (for the particular example of equation [3]) in figure 8. Note that although this bifurcation process produces an infinite sequence of cycles with period 2^n ($n \rightarrow \infty$), the “window” of r values wherein any one cycle is stable progressively diminishes, so that the entire process is a convergent one, being bounded above by some parameter value $r = r_c$ (which in the example [3] is $r_c = 2.6924 \dots$).

So far, we have discussed the way the fixed point of $F(N)$ gives way to a hierarchy of stable cycles of periods 2^n . After first pausing to emphasize that the phenomenon is a generic one, we go on to discuss what happens beyond r_c .

The Generic Character of the Bifurcation Process

In Appendix A we give a mathematically rigorous and detailed account of this bifurcation process for an *arbitrary* $F(N)$. We see that as the fixed point “of period 1,” X^* , becomes unstable [i.e., as the slope $\lambda(X^*)$ steepens beyond -1], there are born a pair of initially stable fixed points of period 2. More generally, as any fixed point of period k becomes unstable, it bifurcates to give two (initially stable) fixed points of period $2k$.

The essential ingredient of the proof consists of the observation that, at any fixed point of period k , $X_i^{*(k)}$, the slope of the intercept of $F^{(2k)}$ with the 45° line, $\lambda^{(2k)}[X_i^{*(k)}]$, is simply the square of the slope of the intercept of $F^{(k)}$ with the 45° line:

$$\lambda^{(2k)}[X_i^{*(k)}] = \{\lambda^{(k)}[X_i^{*(k)}]\}^2. \quad (7)$$

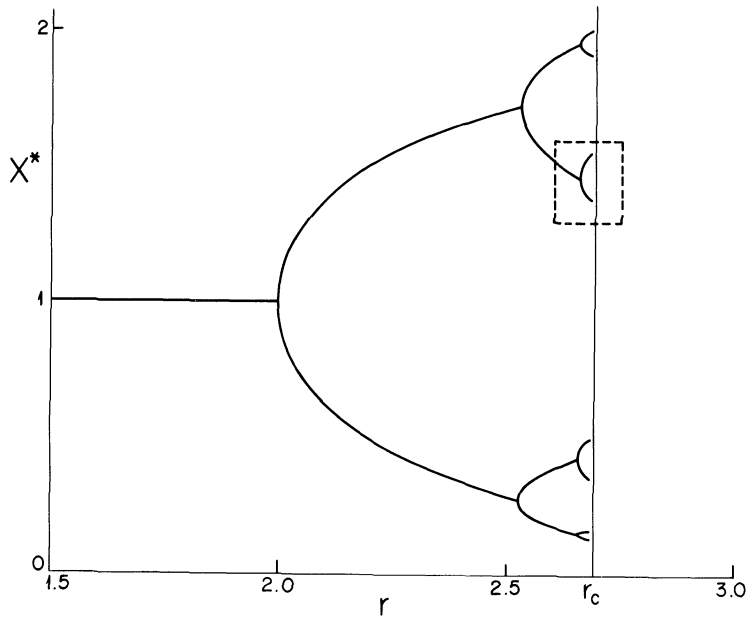

FIG. 8a.—The hierarchy of stable fixed points (each pair arising by bifurcation as a previous point becomes unstable) which are produced as the parameter r of eq. (3) increases. The sequence of stable cycles of period 2^n is bounded by the parameter value r_c .

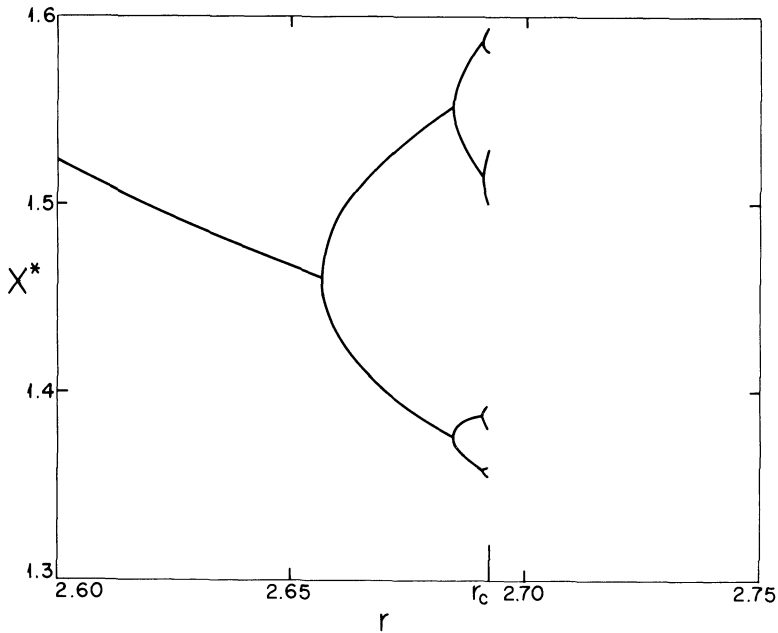

FIG. 8b.—A detailed blowup of the bifurcation process, corresponding to that portion of fig. 8a within the indicated box.

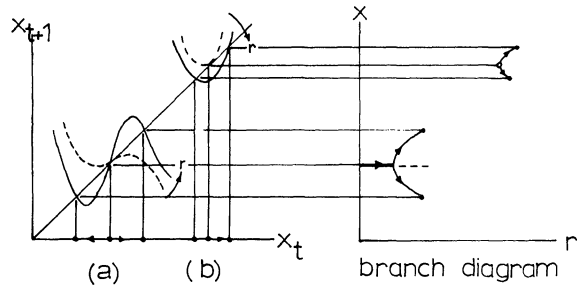

FIG. 9.—*a*, Bifurcation when $\lambda(r) < -1$. *b*, Bifurcation when $\lambda(r) > +1$

Thus if the period k cycle is stable, $-1 < \lambda^{(k)} < 1$, we have $|\lambda^{(2k)}| < 1$, and the kink in $F^{(2k)}$ does not yet intercept the 45° line; i.e., we have the generic character of figure 6*a*. Conversely, once the points of period k become unstable, $\lambda^{(k)} < -1$, we have $|\lambda^{(2k)}| > 1$, and the kink in $F^{(2k)}$ does intercept the 45° line, so that the period k cycle bifurcates into one of period $2k$; i.e., we have the generic character of figure 6*c*.

In short, Appendix A shows the behavior illustrated in figure 8 to be a generic property of "one-hump curves."

A rapidly convergent scheme for calculating the approximate value of the parameter corresponding to the upper limit of the bifurcation process, r_c , is also given in Appendix A.

Finally it is important to note that for more general functions than equation (3) many more complicated things can happen.

For example, not every new solution must arise from bifurcation from a preexisting fixed point. This can happen when a "valley" of some iterate of F deepens and eventually touches the 45° line, or when a "hill" rises to touch it; a pair of fixed points will then appear on the bifurcation diagram. This is illustrated in figure 9 and is the crucial difference between bifurcations from $\lambda(r) = +1$ (the so-called tangent case, fig. 9*b*), and those from $\lambda(r) = -1$ (the so-called slope case, fig. 9*a*, which is discussed in detail above and in Appendix A).

Even for equation (3), higher-order cycles can be born by tangent-type bifurcation. Having appeared, such period k cycles will in turn become unstable, giving rise by slope-type bifurcation to cycles of period $2k$, $4k$, etc. Some specific examples (e.g., a sequence of stable cycles of periods 3, 6, 12, 24, . . . , inhabiting the region $3.196 > r > 3.102$, for equation [3]) are noted in Appendix B.

In dimensions higher than one, the existence of bifurcations to periodic orbits does not even require the presence of a critical point (hump); bifurcation can happen with "almost linear" systems.

Beyond r_c : Chaos

Beyond the limit point r_c in figure 8 there are an infinite number of periodic points. As we shall discuss below, only a finite number of these periodic points

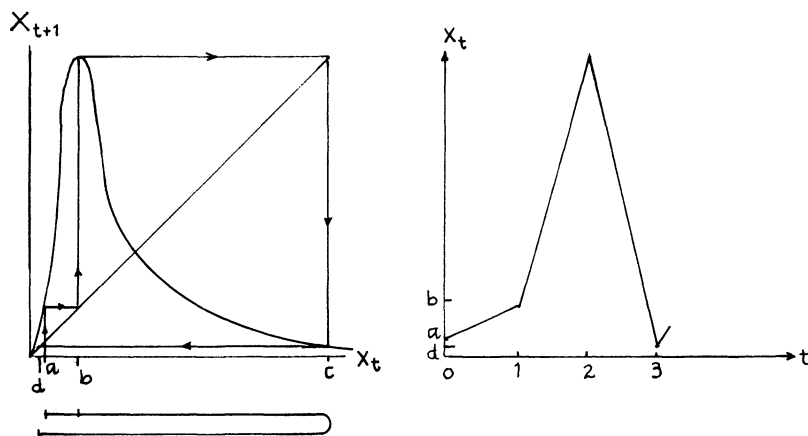

FIG. 10.—If $d \leq a$ (a three-point cycle exists) then there are initial conditions which generate aperiodic trajectories.

can be stable. Furthermore, there are an uncountable number of points (initial conditions) whose trajectories are totally aperiodic; no matter how long the time series generated by $F(N)$ is run out, the pattern never repeats (although it is bounded above and below; see Section III).

Such data is, for all intents and purposes, indistinguishable from a sample function of a stochastic process! Indeed, when the cycle time becomes sufficiently long it will appear aperiodic unless an extremely long and accurate series of data points are available. That is, cycle times longer than the number of data points will not be detectable and can easily masquerade as a stochastic process. That so simple and biologically reasonable a model can exhibit such pathology has disturbing implications for mathematical models of more complex systems. Nor is such pathology a mathematical curiosity; it can arise in innumerable contexts, as we shall discuss in Section IV.

Conditions for the existence of an infinite number of periodic points (and consequently for the existence of cycles of arbitrarily high order), and for the existence of asymptotically aperiodic behavior, may be established for any proposed difference equation, as follows. Starting at the critical point, b , in figure 10, trace out the postimages c and d and the preimage a , as shown. If $a \geq d$ (i.e., d to the left of a) then in addition to an infinite number of periodic points, the function can generate aperiodic motions. A detailed (set-theoretic) proof of this theorem is due to Li and Yorke (1975). Biologically, this condition says that not only is there enough delayed density dependence to cause an overshoot of the equilibrium point (the fixed point is to the right of the critical point), but also the overshoot is sufficiently severe to produce a 3-point cycle, comprising two upward steps, followed by a down. More generally, it may be seen that Li and Yorke's proof applies if there exists any cycle with an odd period, or, indeed, if there is any sequence of k points (a, \dots, b, c) ascending toward the critical point, followed by a crash back to a point (d) below the initial point in the sequence ($a \geq d$); that is, the generalization of figure 10

which preserves the essential feature that d lies to the left of a . This chaotic regime sets in beyond the point at which F is first sufficiently humped to produce an infinite number of periodic points; that is, it begins beyond the critical parameter value r_c of the bifurcation diagram, figure 8.

An intuitive interpretation of these rules can be given in terms of what the map F does to points in its interval of definition. If the general circumstances of figure 10 pertain, then there is a subinterval (ab in fig. 10) which is "folded" under the action of the map (i.e., ab is mapped to bc , and bc is mapped to cd , as shown in fig. 10). If the map is then iterated, an infinite number of times, an infinite number of folds are created in the interval oc . By a well-known theorem from analysis (see, e.g., Smart 1974), there must therefore exist fixed points—an infinite number of them—in the region of overlap. Furthermore, if the condition $d \leq a$ holds, there is an interval (ac in fig. 10) which completely covers itself under F ; if the map is iterated enough times, it can then be shown that the union of the domains of attraction of the stable fixed points will not fill up the interval oc and that the complement of this set must contain, in addition to the repelling fixed points, aperiodic points. This argument contains the essentials of the more formal set-theoretic treatment of the consequences of period 3 by Li and Yorke, and its extensions (e.g., Diamond 1976).

Finally, note that (for any value of r) although there may be an infinite number of fixed points, there can be only a finite number of *stable* fixed points. A rigorous formulation of this result (and of the arguments presented in the preceding paragraph) is due to Guckenheimer (1970). In essentials, the proof follows from the observation that each successive iterate of F crowds twice as many humps into the same interval, so that the slopes of $F^{(k)}$ at its intersections with the 45° line (i.e., at the period k points) must steadily increase with each iteration. Thus it becomes harder and harder for the eigenvalues at the periodic points to remain stable. Consequently, there can only be a finite number of stable periodic points among the infinite number of possible periodic points; exceptions will occur at limiting parameter values such as r_c , but such exceptions will have measure zero on the interval of r values. That is, after a finite number of iterates of F , *all* slopes at the periodic points have magnitude in excess of unity, and so successive iterates produce only repelling periodic points. Thus beyond r_c the domain of F must be partitioned into at least two sets of points: (i) the domain of attraction of the finite number of periodic points, and (ii) the complement of (i) containing both an infinite number of unstable periodic points and an uncountable number of points which wander aperiodically.

A more detailed exploration of the dynamical behavior in the region beyond r_c is presented in Appendix B.

II. ECOLOGICAL IMPLICATIONS

Note that as r is made very large in equation (3), the hump on the graph of F grows very large and moves to the left (see fig. 4). An initial condition very close to zero will take a large number of steps to get away from the origin, whereupon it will suddenly make a large jump to a very high amplitude, and

thence crash back to very small amplitude (since the higher the hump, the faster the curve falls off). The time trajectory will then exhibit the character of a periodic outbreak: several periods of low, or even undetectable, population growth until a "threshold" is exceeded, whereupon a large excursion takes place, followed immediately by a crash back to a very low level. This is evocative of the apparent behavior of many invertebrate populations (e.g., grasshoppers, budmoths).

The periodic crashes, however, generally will not return the population to exactly its initial level. Consequently the cycle will not close on itself, being exactly periodic, but rather may appear "almost periodic." This is analogous to the orbit traced out on a pool table by a ball whose initial velocity is given an irrational angle with the sides of the table. The trajectory of the ball will never be periodic but will cover the entire table, coming arbitrarily close to every point. However, if the ball is started at a rational angle close to the irrational angle, then the orbit will be periodic (albeit with a very long period). Moreover, for a long time the "chaotic" orbit will be close to the periodic one and may appear nearly periodic. Similarly, the "orbit" drawn out on the graph of F (after the fashion of fig. 2*b*) can "walk around," never quite closing to a periodic trajectory.

As already stressed, the behavior of the simple model (3) as the parameter r is varied is typical. All the models in table 1 can perform identical mathematical gymnastics. (For a reasonably detailed study of the bifurcation properties of equation 2 of table 1, see Li and Yorke [1975], or May [1974*b*]; for equation 4, see Hassell et al. [1976].)

The implications for ecological theory of these high-order periods and aperiodic orbits are most unsettling. It means that, from a modeling point of view, it may well be practically impossible to distinguish data that have been generated by a rather simple deterministic process either from true stochastic noise or from "experimental error" in sampling or measurements. The decision as to when sufficiently accurate data have been collected, and whether the data show purely stochastic or deterministic characteristics, may well have to rest with one's biological knowledge external to the experiment, since no discrimination between the three alternatives can be given on the basis of the data alone.

A simple and startling example of the problem is shown in figure 11. If we agree to count any point that lands in the left half of the interval as 0 and any point in the right half as 1 (i.e., round to the nearest integer), then either graph will generate a sequence of 0's and 1's that are indistinguishable from a Bernoulli process consisting of a sequence of coin tosses! This deterministic process is equivalent to the simplest stochastic process.

One might think that a simple way out of this dilemma if presented with a set of apparently unpatterned results would be to try and reconstruct a generating function for the trajectory by plotting all adjacent pairs (X_t, X_{t+1}) ; that is, by inverting the direction of the arrows in figure 2*b*. If a sequence of points was generated deterministically by a function, F , then certainly F should be reconstructable by inverting the process. In principle this could work, and, indeed, should be attempted with any such data. However, in practice this

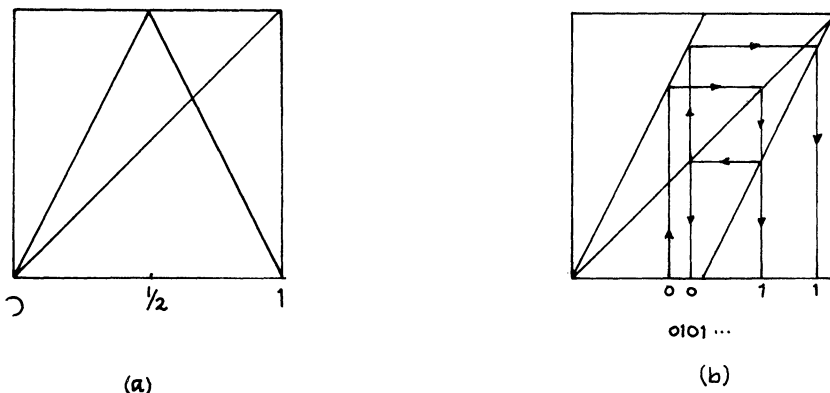

FIG. 11.—Two functions that generate sample functions of a Bernoulli process. Remark: The extension of the initial condition in *b* in base 2 is a sequence of 0's and 1's which is the same as would be generated by the orbit of *F*.

procedure is unlikely to reproduce *F* since *even small errors in measurement will "fuzz out" the graph of F*. Likewise, even a very tiny amount of stochastic fluctuation in the value of *r* will, for large *r*, fuzz out the reconstructed graph of *F*. Thus, projecting back pairs of points on the (*X_t*, *X_{t+1}*) plane will generally produce a cloud of points. Passing a curve through the cloud (by, say, a least-squares fit) may produce a function, *F-hat*, whose trajectory will at best approximate that of *F* for a short time. Such a procedure is really quite delicate, since *F-hat* is good only for the *given* initial conditions. If the initial conditions are changed then a completely different trajectory is likely to be traced by *F-hat*, which may bear little resemblance to that generated by the true *F*.

Of course, if the underlying dynamics is either stochastic, or arises from a deterministic model of higher dimension (e.g., the time trajectory of a host-parasite system), then the points (*X_t*, *X_{t+1}*) will produce no discernible pattern.

III. EXTINCTION

Notice that, if *F(N)* has a hump, no matter how complicated the dynamics may become the population variable has an upper bound. If the critical point is at *N₀* (i.e., *dF/dN = 0* for *N = N₀*), then clearly the population is bounded *above* by

$$N_{\max} = F(N_0). \tag{8}$$

Apart from possible initial transients, the minimum attainable population value is in the generation immediately subsequent to the maximum value. That is, the population is bounded *below* by

$$N_{\min} = F[F(N_0)] = F^{(2)}(N_0). \tag{9}$$

For example, for equation (3) the critical point is at *X₀ = 1/r*, whence the variable *X_t* is bounded above by *X_{max} = (1/r) exp (r - 1)*, and bounded below by *X_{min} = (1/r) exp (2r - 1 - e^{r-1})*.

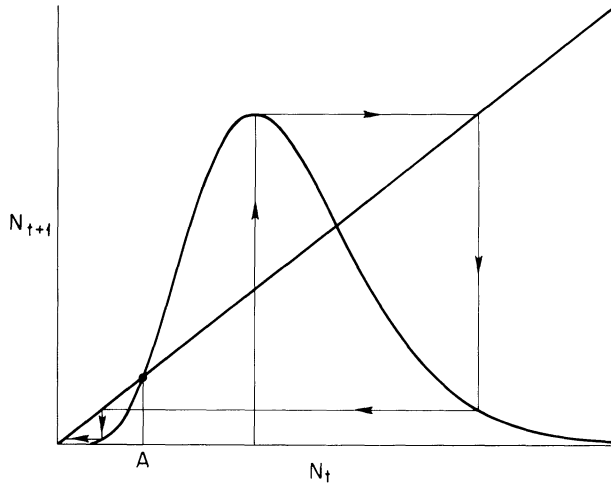

FIG. 12.—Illustrating a density-dependent difference equation which generalizes the form illustrated in fig. 2 by incorporating an Allee effect. Populations falling below the value A will be attracted to zero. As indicated on the figure, if the hump is sufficiently steep, population values in the neighborhood of the critical point will in the next generation fall below A , and then head for extinction.

This is all very well if we are interested in the mathematical problem where N_t or X_t is a continuous variable, which can be arbitrarily small so long as it remains positive. But animals come in integer units, and if N were to assume values less than, or of the order of, unity, then we would expect the population to become extinct. (More rigorously, a stochastic description in which population values assume only integer values is necessary, but the approximation of treating N as a continuous variable, with extinction certain if $N \lesssim 1$, should be at least qualitatively accurate.)

Thus we would expect extinction of our model population once F becomes so steeply humped that

$$F^{(2)}(N_0) \leq 1. \tag{10}$$

Applied to the specific example (3), this implies extinction for r in excess of the value roughly determined by

$$1/K = (1/r) \exp(2r - 1 - e^{r-1}). \tag{11}$$

For instance if $K = 10^6$ this requires $r < 3.964$ for persistence of the population. As another example, notice that for the quadratically nonlinear equation 2 of table 1 the population is bound to go negative, i.e., to become extinct, once $r > 3$.

Furthermore, some biological populations display an Allee effect, whereby population levels decline if they fall below some lower threshold value, A say (see, e.g., Watt 1968; Clark 1976). This property, which can arise from a variety of biological behavioral mechanisms, is illustrated in figure 12. Clearly, in this event, extinction is likely if

$$N_{\min} = F^{(2)}(N_0) \leq A. \tag{12}$$

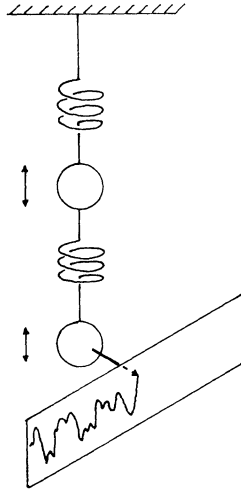

FIG. 13.—Schematic illustration of a double pendulum with nonlinear springs and the consequent apparently chaotic strip-chart record of its motion.

The previous exposition indicated three general regimes of dynamical behavior: stable point, stable cycles of period 2^n , and the complicated (chaotic) regime beyond r_c . Practical considerations dictate the acknowledgment of a fourth regime, namely, extinction, at yet higher values of r : such extinction is produced when $F(N)$ carries population values below some threshold Allee value, or, at very least, below unity.

IV. OTHER EXAMPLES OF COMPLICATED DYNAMICS PRODUCED BY BIFURCATIONS

The occurrence of complex dynamical behavior is by no means restricted to simple one-dimensional difference equations.

Here we list a few examples of simple, deterministic physical and ecological models which exhibit complex behavior of the sort we have described, i.e., apparently stochastic dynamics arising from deterministic models.

1. A simple mechanical example. The double pendulum shown in figure 13 is capable of extraordinarily bizarre motions if the springs are nonlinear, a fact well known to Poincaré. If a stylus were attached to one of the weights, and a strip chart recording of the motion taken, the output would be, after a long time, scarcely discernible from noise. The state space lies on a three-dimensional torus and is one of the simplest examples of a "strange attractor" (i.e., neither a point nor a periodic orbit). A picture of the orbits is given in Arnold and Avez (1970).

2. Fluid mechanics. The equations of fluid mechanics are partial differential equations which contain a parameter, the Reynold's number, analogous to r in equation (3). As this parameter increases, the fluid flow pattern changes from a smooth ("laminar") flow to an irregular, turbulent motion that can only be characterized statistically. This chaotic motion is thought to arise from multiple bifurcations analogous to, but more complicated than, the situation we have described for difference equations (see Ruelle and Takens 1971).

3. Population dynamics. The equations governing a population with age structure are formally identical in many respects with the equations governing fluid motion. By varying parameters controlling fecundity, the equations exhibit bifurcations to multiply periodic orbits which generate a complex spectrum of “waves” in the age structure (Oster and Takahashi 1974). These periodicities have a decisive influence on the coexistence of host-parasite populations, which has been verified in experimental ecosystems (Auslander et al. 1974).

4. Population genetics. The parameter, r , controlling the bifurcations in equation (3) could be interpreted as the average net reproductive rate of the population. However, the raw material of natural selection and evolution is the variation between individuals of a population. We can write an equation analogous to (3) which takes into account a continuous phenotypic variation of any quantitative trait (Slatkin 1970; Oster and Rocklin 1976):

$$N_{t+1}(x) = \iint L(x | x_1, x_2)\phi(x_1, x_2)S(x_1, N_t)N_t(x_1)S(x_2, N_t)N_t(x_2) dx_1 dx_2. \tag{13}$$

Here we have defined

$L(x | x_1, x_2)$ = distribution of offspring phenotypes of the parents, x_1 and x_2 ,

$\phi(x_1, x_2)$ = assortive mating function,

$S(x_i, N)$ = survivorship of phenotype x_i ,

$$N_t = \int N_t(x) dx.$$

By integrating over phenotypes, we can obtain a difference equation identical with equation (3). However, the parameter, r , now is a functional of the phenotype distribution, $N(x)$. If we agree to characterize the distribution by its first two moments, then $r = g(\mu, \sigma)$, where μ and σ are the mean and variance of $N(x)$. If r_i ($i = 1, 2, 3, \dots$) are the bifurcation values of r , then the inverse image of the r_i , $g^{-1}(r_i)$, divides the (μ, σ) plane into disjoint regions, each characterized by a periodic orbit; i.e., the interval between bifurcation points on the r axis in figures 6–8 now corresponds to two-dimensional regions on the (μ, σ) plane. A shift in the phenotype distribution, x , arising from any selective influence which moves the point (μ, σ) across one of these boundaries will excite periodic, or even chaotic, motion. Thus all of the dynamic complexity arising from multiple bifurcations can be generated from processes, difficult to observe macroscopically, generated *internal* to the population. Such dynamics can only be understood by recognizing the variations between individuals in a population. (The generation of periodic behavior in populations can have profound effects on the genetic structure of a population due to the strong selection that occurs at the minima of the oscillations; see Oster et al. [1976]; Gilpin [1975].)

5. Host-parasite systems. Assuming discrete generations, the host population, H_t , and parasite population, P_t , can be modeled by equations of the general form

$$H_{t+1} = F(H_t, P_t), \tag{14}$$

$$P_{t+1} = G(H_t, P_t). \tag{15}$$

Such systems can also show the continuum of behavior from stable points, through stable cycles, to a chaotic regime. Preliminary studies by Beddington et al. (1975) suggest the bifurcation phenomenon and attendant complications arise more readily than in our one-dimensional examples.

6. Competing species. Similarly, systems of two competing populations show this range of behavior. One example is the pair of equations

$$\begin{aligned} X_{t+1} &= X_t \exp [r_1(1 - X_t - \alpha Y_t)], \\ Y_{t+1} &= Y_t \exp [r_2(1 - Y_t - \beta X_t)]. \end{aligned} \quad (16)$$

Again it appears that bifurcations, and consequent chaotic behavior, are attained for smaller r values than for the corresponding simple one-dimensional systems (Hassell and Comins 1976; May 1974a).

7. Quadratic nonlinearities in n dimensions. In an interesting and extensive series of numerical experiments, Ulam (1963) has explored three- and four-dimensional systems of difference equations with quadratic nonlinearities. He noted the chaotic dynamics which ensued once the nonlinearities were sufficiently strong and went on to map out the state space "probability distribution" consequent upon such apparently stochastic behavior.

8. The Fermi-Pasta-Ulam (FPU) problem. This concerns the apparently chaotic aspects of the oscillations of a linear array of n mass points ($n \gg 1$), with neighbors coupled by springs which have very weak nonlinear terms. The problem by now enjoys a large literature of numerical studies: a recent review and bibliography is by Tuck and Menzel (1972).

The bulk of this paper has dealt with the complicated bifurcation processes which can occur in a one-dimensional system once the nonlinearities are sufficiently strong. The FPU problem represents the opposite end of a spectrum of possible models and shows the same chaotic dynamical behavior, in this case for a high-dimensional system with almost imperceptible nonlinearity. From this, and other studies of intermediate-dimensional systems (two-, three- and four-dimensional systems such as examples 5-7 above), we conjecture that the sort of complications seen above for large r in single-species systems can arise even more easily in multispecies systems.

V. DISCUSSION

It has been shown, very generally, that a density-dependent relation of the form illustrated by figure 2 will lead to dynamical behavior which (as the hump in the F curve steepens) goes from a stable point, through a bifurcating hierarchy of stable cycles of period 2^n , into a region of chaotic behavior, and finally leads to extinction for very steep curves.

Since such nonlinear difference equations are appropriate to many real-life situations, and particularly to temperate-zone insect populations, these properties have ecological implications. Some of these are developed in Section II. In particular, we emphasize that data indicating complicated population fluctuations do *not* necessarily testify to environmental stochasticity, nor to random

experimental error, but can arise from simple and rigidly deterministic density-dependent mechanisms.

The detailed *biological* implications for the analysis of data pertaining to single-species populations remain to be explored. Southwood (1975) has given an account of some of the general implications, particularly for invertebrate ecology. Hassell et al. (1976) have analyzed a large array of life tables for species in a variety of taxonomic categories, fitting this data to the two-parameter density-dependent relation of equation 4 of table 1: most of these populations appear to be in the stable point region, or, at worst, in the region of two- or four-point cycles. There are, however, considerable difficulties in this kind of data analysis, and these conclusions should only be regarded as tentative.

As pointed out in Section II, fine mathematical points as to whether we have a cycle of very long period, or totally aperiodic motion, are of little biological relevance: both will appear chaotic (or perhaps almost periodic). However, these and other such things are of intrinsic *mathematical* interest. The bifurcation diagram in figure 8 is itself of considerable pedagogic value as an explicit example of a bifurcation process in a very simple system. Similarly the algorithm for calculating r_c (the limit of the bifurcations) and some details of the behavior as a function of r beyond r_c are new results of mathematical interest. These aspects of our work are developed in Appendix A–Appendix C.

Indeed, on a pedagogic note, it could be argued that a study of very simple nonlinear difference equations such as equations 1 and 2 of table 1 should be part of high school or elementary college mathematics courses. They would enrich the intuition of students who are currently nurtured on a diet of almost exclusively linear problems.

Section IV reviews several other examples of complicated dynamical behavior arising from bifurcation processes. Although most of these examples are not as well understood as our simple one-dimensional model, they suggest that such apparently chaotic dynamics is ubiquitous phenomenon, and that it can arise more readily (with weaker nonlinearities) in systems of higher dimensionality.

VI. SUMMARY

Many biological populations breed seasonally and have nonoverlapping generations, so that their dynamics are described by first-order difference equations, $N_{t+1} = F(N_t)$. In many cases, $F(N)$ as a function of N will have a hump. We show, very generally, that as such a hump steepens, the dynamics goes from a stable point, to a bifurcating hierarchy of stable cycles of period 2^n , into a region of chaotic behavior where the population exhibits an apparently random sequence of “outbreaks” followed by “crashes.” We give a detailed account of the underlying mathematics of this process and review other situations (in two- and higher dimensional systems, or in differential equation systems) where apparently random dynamics can arise from bifurcation processes.

This complicated behavior, in simple deterministic models, can have disturbing implications for the analysis and interpretation of biological data.

ACKNOWLEDGMENTS

We are indebted to J. M. Beddington, J. Guckenheimer, J. Marsden, W. Thurston, and J. A. Yorke for stimulating discussions. This work was supported in part by NSF grants BMS 74-21240 (G. F. O.) and BMS 75-10646 (R. M. M.). One of us (R. M. M.) is beholden to Professor H. Messell, director of the Research Foundation for Physics within the University of Sydney, for his hospitality during the completion of part of this work.

APPENDIX A

As a stable cycle of period k becomes unstable, it bifurcates into an initially stable cycle of period $2k$. In this Appendix we discuss how this comes about and show what the limits are to this process.

Suppose we have a k -point cycle, touching the fixed points $N_i^{*(k)}$ (with $i = 1, 2, \dots, k$) which are the solutions of

$$N^{*(k)} = F^{(k)}[N^{*(k)}]. \quad (\text{A1})$$

The stability-determining eigenvalues $\lambda^{(k)}$ are given by the slope of $F^{(k)}$ at these points:

$$\lambda^{(k)}[N_i^{*(k)}] = [dF^{(k)}(N)/dN]_{N=N_i^{*(k)}}. \quad (\text{A2})$$

By applying the chain rule, it can readily be seen that this reduces to

$$\lambda^{(k)} = \prod_{i=1}^k [dF(N)/dN]_{N=N_i^{*(k)}}. \quad (\text{A3})$$

(Samuelson 1947; Li and Yorke 1975). So the derivative of the k -times-composed function $F^{(k)}$ can be replaced by the product of the derivatives of F at the k fixed points. It follows that the slope $\lambda^{(k)}$ is necessarily the same at all k fixed points. As illustrated in figure 14a, if $1 > \lambda^{(k)} > -1$, the k -point cycle is at least locally stable, while if $\lambda^{(k)} < -1$ (or > 1) the cycle becomes unstable.

Next consider the map of $F^{(2k)}$. Clearly the fixed points of period k , $N_i^{*(k)}$, are solutions of the equation

$$N = F^{(2k)}(N) = F^{(k)}[F^{(k)}(N)]. \quad (\text{A4})$$

That is, the k -point cycle is a degenerate case of a $2k$ -point cycle. The slope of $F^{(2k)}$ at these period k fixed points, $\lambda^{(2k)}[N^{*(k)}]$, is given by

$$\begin{aligned} \lambda^{(2k)}[N^{*(k)}] &= [dF^{(2k)}(N)/dN]_{N=N^{*(k)}} \\ &= \{[dF^{(k)}/dN]_{N=N^{*(k)}}\}^2 \\ &= \{\lambda^{(k)}[N^{*(k)}]\}^2. \end{aligned} \quad (\text{A5})$$

Thus if the k -point cycle is stable, $|\lambda^{(k)}| < 1$ and therefore $\lambda^{(2k)} < 1$ [the slope of $F^{(2k)}$ is less than 45°]. The situation is depicted by the dashed curve in figure 14b, where no nondegenerate $2k$ -point cycle yet exists: i.e., the kinks in the map of $F^{(2k)}$ do not yet intercept the 45° line. However, when the k -point cycle becomes unstable, $|\lambda^{(k)}| > 1$ and consequently $\lambda^{(2k)} > 1$ [the slope of $F^{(2k)}$ exceeds 45°]. We now have the situation depicted by the solid curve in figure 14b where two new points of period $2k$ appear. That is, as a period k point becomes unstable, it necessarily bifurcates to two new points, which are initially stable points of period $2k$. There will be $2k$ such points, which we denote by $N_i^{*(2k)}$ ($i = 1, 2, \dots, 2k$).

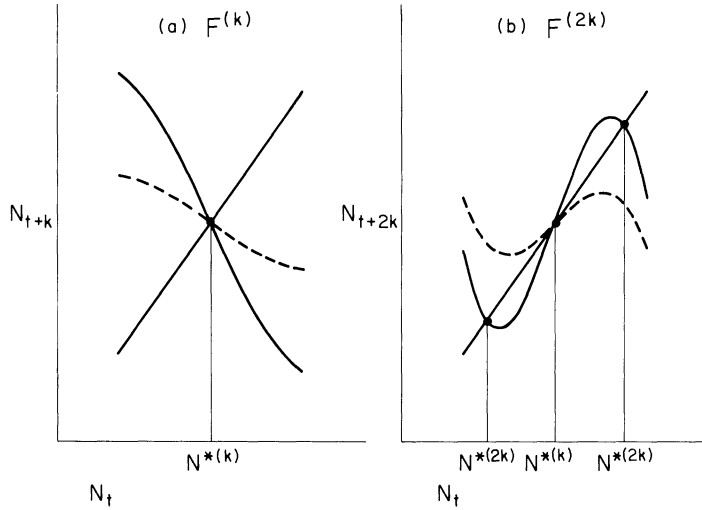

FIG. 14.—*a*, The dashed curve illustrates the map of $F^{(k)}$ (relating N_{t+k} to N_t) in the neighborhood of one of its period k fixed points, $N^{*(k)}$; here the slope of $F^{(k)}$ at its intersection with the 45° line, $\lambda^{(k)}$, has $|\lambda^{(k)}| < 1$, and the point is stable. For the solid curve $|\lambda^{(k)}| > 1$, and the fixed point becomes unstable. *b*, This figure illustrates the corresponding maps of $F^{(2k)}$ (relating N_{t+2k} to N_t), in the neighborhood of the same period k fixed point, $N^{*(k)}$. The consequent features are as discussed in the text. Note that $\lambda_0^{(2k)}$ is defined as the slope of $F^{(2k)}$ at $N^{*(k)}$, and $\lambda^{(2k)}$ as the slope at the newly bifurcated period $2k$ fixed points, $N^{*(2k)}$ (which arise once $|\lambda^{(k)}| > 1$, eq. [A5]).

This mechanism is clearly generic. Starting from any one-hump map, F , the bifurcation process gives rise to a succession of stable cycles of periods 1, 2, 4, 8, . . . , 2^n , . . . , as typified by figure 8. Equally well, beyond r_c there can be locally attractive fixed points of period k which, as F continues to steepen, lead to bifurcating sequences of stable cycles with periods $k, 2k, 4k, \dots, 2^n k, \dots$ (e.g., $3 \rightarrow 6 \rightarrow 12 \rightarrow 24, \dots$, or $5 \rightarrow 10 \rightarrow 20 \rightarrow 40, \dots$; see Appendix B).

An interesting number is the limiting parameter value for any such sequence of bifurcations. For example, consider the parameter sequence shown in figure 8. One way to find r_c is simply to compute the r value at which instability sets in for cycles of successively higher orders (e.g., 512; 1,024; 2,048). This is a straightforward but tedious task.

To concoct an analytic approximation it is first helpful to introduce some compact notation. For the parameter value r , let $\lambda^{(k)}(r)$ denote the slope of $F^{(k)}$ at any one of the period k fixed points, $N_i^{*(k)}$ (i.e., eq. [A3]); similarly, let $\lambda^{(2k)}(r)$ denote the slope of $F^{(2k)}$ at any one of the period $2k$ fixed points, $N_i^{*(2k)}$ (if they exist); and finally let $\lambda_0^{(2k)}(r)$ denote the slope of $F^{(2k)}$ at the period k fixed points, $N_i^{*(k)}$ (i.e., eq. [A5]). Figure 14 aims to clarify this. Now if we could relate $\lambda^{(2k)}(r)$ to $\lambda^{(k)}(r)$, the condition for instability of the period $2k$ cycle could be expressed in terms of the slope (already steeper than -1) at the period k fixed points.

For relatively large k , an approximate such relation is (see proof below)

$$\lambda^{(2k)}(r) \simeq 3 - 2[\lambda^{(k)}(r)]^2. \tag{A6}$$

Thus $\lambda^{(2k)} = -1$ implies, approximately, that $\lambda^{(k)} = -\sqrt{2}$. By extension, we can relate the condition for instability of the period $2^n k$ cycle to the slope at the con-

TABLE 2

COMPARISON BETWEEN EXACT VALUES OF r_c , AND APPROXIMATIONS BASED ON EQUATION (A9), FOR DIFFERENCE EQUATIONS 1 AND 2 OF TABLE 1

Approximation Based on Cycle of Period k : $r_c(k)$	For Eq. (1) of Table 1 (i.e., Eq. [3])	For Eq. (2) of Table 1
$k = 1, r_c(1)$	2.50	2.50
$k = 2, r_c(2)$	2.667	2.550
$k = 4, r_c(4)$	2.686	2.566
$k = 8, r_c(8)$	2.691	2.569
$k = 16, r_c(16)$	2.6921	2.5697
$k = 32, r_c(32)$	2.6923	2.5699
Exact value, r_c	2.6924	2.5700

siderably simpler fixed points of period k . The limiting parameter value, r_c , is defined for any such sequence of bifurcations as that value of r such that

$$\lim_{n \rightarrow \infty} \lambda^{(2^n k)}(r_c) = -1. \tag{A7}$$

It only remains to relate this limiting slope at the period $2^n k$ points to the slope at the period k points. This is accomplished via repeated applications of the approximate equation (A6):

$$\lambda^{(k)}(r) \simeq [\frac{1}{2}(3 + [\frac{1}{2}(3 + [\dots \frac{1}{2}(3 - \lambda^{(2^n k)}(r)) \dots]^{1/2})^{1/2})]^{1/2}. \tag{A8}$$

(The square roots are all to be taken negatively.) The result, in the limit $n \rightarrow \infty$, is

$$\lambda^{(k)}(r_c) \simeq -1.5. \tag{A9}$$

In this way r_c can be estimated in terms of the properties of relatively low-order (period k) cycles in the sequence.

The efficacy of this approximation scheme is illustrated in table 2. This table refers to the difference equations 1 (i.e., eq. [3]) and 2 of table 1 and compares the exact value of the limit to the bifurcating cycles of period 2^n , r_c , with the successively more accurate approximations $r_c(1), r_c(2), \dots, r_c(32)$ obtained by applying equation (A9) to the cycles of period 1, 2, ..., 32, respectively. The approximation is seen to be qualitatively accurate even if based on the slope of the single fixed point of F , and adequate for most practical purposes by the time $k = 4$ or 8. This analytic approximation to r_c is especially useful for finding the limiting parameter values in difference equations with two or more parameters, such as equation 4 of table 1.

Proof of the approximate equation (A6). For relatively large k , we expand $F^{(2k)}$ in a Taylor series to third order about the point $N^{*(k)}$:

$$F^{(2k)}[N^{*(k)} + y] \simeq N^{*(k)} + Ay + \frac{1}{2}By^2 + \frac{1}{6}Cy^3. \tag{A10}$$

The expansion needs to be carried at least to order y^3 to account for the qualitative shape of $F^{(2k)}$ in the neighborhood of $N^{*(k)}$ (see fig. 14b); that is, in order to describe bifurcation into a pair of points, one on either side of $y = 0$. Remembering that

$$F^{(2k)}[N^{*(k)} + y] \equiv F^{(k)}\{F^{(k)}[N^{*(k)} + y]\} = F^{(k)}[N^{*(k)} + \lambda^{(k)}y + \dots], \tag{A11}$$

we can express the coefficients A, B , etc., in terms of derivatives of the lower-order map $F^{(k)}$. In this way, we have already shown in equation (A5) that

$$A = [\lambda^{(k)}]^2. \tag{A12}$$

Similarly,

$$B = [\lambda^{(k)}][1 + \lambda^{(k)}][d^2F^{(k)}/dN^2]_{N=N^{*(k)}}. \tag{A13}$$

Notice that the fixed points of period k bifurcate at $\lambda^{(k)}(r) = -1$, so that for r just beyond this value $A \simeq 1$ and $B \simeq 0$.

For the fixed points of period $2k$, we write $N^{*(2k)} = N^{*(k)} + y^*$ (see fig. 14*b*). The values of y^* are then determined by

$$y^* \simeq Ay^* + \frac{1}{2}By^{*2} + \frac{1}{6}C(y^*)^3. \tag{A14}$$

Apart from the degenerate period k solution, $y^* = 0$, there is a pair of solutions given by

$$0 \simeq (A - 1) + \frac{1}{2}By^* + \frac{1}{6}C(y^*)^2. \tag{A15}$$

Note that these solutions are real if, and only if, $A \geq 1$ (i.e., $|\lambda^{(k)}| \geq 1$), in accord with the detailed discussion given earlier. Next, the slope at these period $2k$ fixed points is

$$\lambda^{(2k)} = [dF^{(2k)}/dy]_{y=y^*} \simeq A + By^* + \frac{1}{2}C(y^*)^2. \tag{A16}$$

Using equation (A15), this can be simplified to

$$\lambda^{(2k)} \simeq (3 - 2A) - \frac{1}{2}By^*. \tag{A17}$$

The quantity y^* , which represents the distance between the unstable period k point and the initially stable period $2k$ point [$y^* = N^{*(2k)} - N^{*(k)}$], will be small even for moderate values of k , and will be very small for large k : figure 8 makes this plain. In addition, the coefficient B is zero when the bifurcation first occurs (see eq. [A13]). Thus, to a first approximation, the correction term $\frac{1}{2}By^*$ may be neglected in equation (A17): after eliminating A by use of equation (A12) one arrives at the approximation (A6). Rather than undertake an explicit evaluation of the correction terms in this approximation for large k , we instead take the empirical view of referring to table 2.

APPENDIX B

Beyond the critical value, r_c , of figure 8, we enter the regime termed by Yorke "chaotic," characterized (for essentially all values of r) by a finite number of attracting fixed points, an infinite number of repelling fixed points, and an uncountable number of asymptotically aperiodic initial conditions. As discussed in Section II, from a biological point of view it is essentially irrelevant whether the solution is aperiodic or periodic with long period: these are likely to be indistinguishable in practice, and small fluctuations in r or in data collected are likely to blur the distinction, even if it did exist.

Despite their biological irrelevance, the mathematical details of the dynamical behavior in the chaotic regime are curious, and we discuss them briefly in this Appendix.

It is difficult to make sense of numerical simulations of equations such as (3) without this understanding.

How many fixed points are there with period k ? As the map of F becomes more and more steeply peaked, it becomes a one-dimensional analogue of the "horseshoe" map of Smale (Smale 1967; Hirsch and Smale 1974). Were it a true horseshoe (which it cannot be on \mathbf{R}^1), it is easy to prove that there are 2^k fixed points of period k . Thus for large r , as F becomes very peaked, we may anticipate realizing 2^k fixed points of period k , at least for values of k which are not too large. An equivalent way of framing this argument is to note that composing a one-hump map with itself produces a map, $F^{(2)}$, with two humps (cf. fig. 5); composing with $F(\cdot)$ once again produces a map, $F^{(3)}$, with four humps; etc. As each successive composition doubles the number of humps, the map of $F^{(k)}$ will have 2^{k-1} humps. If all these humps and valleys are sufficiently steep (which they increasingly tend to be as r increases),

TABLE 3

r VALUES LEADING TO VARIOUS HIGHER-ORDER HIERARCHIES OF STABLE CYCLES IN EQUATION (3)

k , Period of Basic Cycle	Originates at r_A	Goes Unstable at r_B	Subsequent Hierarchy of Periods 2^nk Bounded by r_c
1 (see fig. 8)	0	2	2.6924
3	3.1024	3.1596	3.1957
4	3.5855	3.6043	3.6153
5 (first)	2.9161	2.9222	2.9256
5 (second)	3.3632	3.3664	3.3682
5 (third)	3.9206	3.9295	3.9347

there will be 2^k points of intersection with the 45° line (i.e., 2^k period k fixed points).

It is instructive to examine how these 2^k fixed points are organized, for some specific values of k .

1. For $k = 1$, we have $2^1 = 2$ possible fixed points, namely, the trivial solution $N^* = 0$, and the nontrivial fixed point N^* of figure 2.

2. For $k = 2$, we have $2^2 = 4$ possible fixed points, namely, the two fixed points of period 1, and the two period 2 fixed points arising from the slope-type bifurcation at N^* (fig. 8).

3. For $k = 3$, we have $2^3 = 8$ possible fixed points. These are the invariable two period 1 fixed points of 1, together with a pair of 3-point cycles which are born simultaneously (one being initially stable, the other unstable from the outset), by a tangent-type bifurcation, as the humps and valleys of $F^{(3)}$ steepen for larger r . As r increases further, the slope of $F^{(3)}$ at the (initially attractive) period 3 fixed points steepens, and the stable 3-point cycle gives way to a bifurcating hierarchy of stable cycles of period 3, 6, 12, 24, . . . , 3×2^k . Just as for the basic sequence illustrated by figure 8, this sequence will be bounded by some limiting value of r , and this spectrum of solutions will occupy some finite window of r values in the chaotic regime.

4. For $k = 4$, we have $2^4 = 16$ possible fixed points. Of these, eight are the four fixed points of period 2 from 2, along with the four points arising from slope-type bifurcation of the 2-point cycle (fig. 8). The remaining eight arise as a pair of 4-point cycles coming from a tangent-type bifurcation at larger r : as always happens in this event, one such cycle is stable when it first appears, the other unstable from the outset.

5. For $k = 5$, we have $2^5 = 32$ possible fixed points. These are now the two period 1 points of 1, together with three distinct pairs (one unstable, one initially stable) of 5-point cycles: $2 + 3(5 + 5) = 32$.

This analysis can be extended ad nauseam. For example, for $k = 11$ we have $2^{11} = 2,048$ possible fixed points, which can be sorted out as the two period 1 fixed points of 1, together with 93 distinct pairs of 11-point cycles, all of which can be realized if r is sufficiently large. [Indeed, in this way one can prove the amusing number-theoretic result that $(2^{k-1} - 1)$ is divisible by k if k is prime.]

By way of illustration of these generic results, table 3 gives the windows of r values wherein are located the stable cycles of periods 3, 4 (from tangent-type bifurcation), and 5, for the difference equation (3). For each case, we give the r value (r_A) at which that stable k -point cycle first appears; the r value (r_B) at which it becomes unstable, giving rise by slope-type bifurcation to a hierarchy of stable (2^nk)-point cycles; and the subsequent r value (r_c) which puts an upper limit on this bifurcation process. In brief, table 3 is a summarized version of figure 8 for higher-order cycles originating from tangent-type bifurcations. Numerical studies suggest

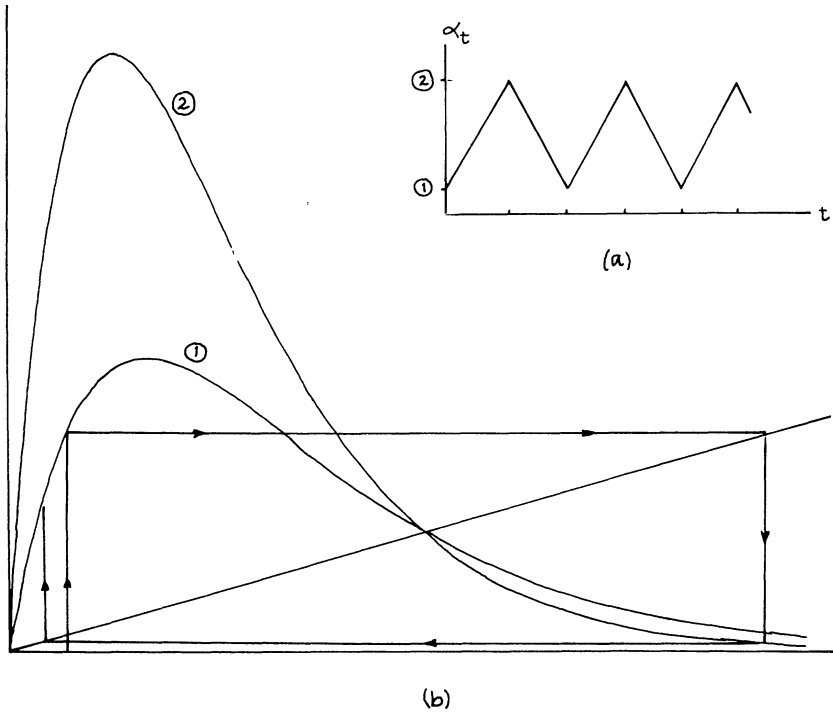

FIG. 15.—If the parameter α in the general difference equation (1) itself varies periodically, as shown here in (a) for $T = 2$, then the graphical analysis of the dynamical behavior is carried out along the lines illustrated in (b). For details, see the text.

that within these windows of r values the appropriate cycles attract essentially all initial points (the exceptions being a class of measure zero which belong to the infinite number of unstable fixed points or the uncountable number of aperiodic trajectories).²

Although these results are of intrinsic mathematical interest, the fact that numerical simulations shed little light on them is an excellent measure of their biological irrelevance. Cycles with long periods are for all practical purposes indistinguishable from chaos. This reechoes the caveats issued in the first paragraph of this Appendix.

APPENDIX C

The graphical method described in Section I can be extended to the case where the parameter α is itself a periodic function: $\alpha_{t+T} = \alpha_t$. For example, suppose α_t varies periodically as shown in figure 15a. Then, we plot two copies of $F_{\alpha_t}(X_t)$ —one for each value of the parameter—and alternate the steps between the two curves as shown in figure 15b. If α_t has period T then T copies of $F_{\alpha_t}(X_t)$ must be drawn.

² Two recent accounts, which are both more complete and more mathematically detailed, are Guckenheimer et al. (1976) and May (1976).

The local stability of the fixed point cannot be determined by computing the eigenvalue except in special cases. For example, the condition for local stability of equation (3) is:

$$\left| \prod_{k=1}^{T-1} (1 - r_k) \right| < 1.$$

[In general, the linear stability condition for the difference equation $X_{t+1} = A_t X_t$ is $\|\Phi(t_0, t)\| < M$, where $\Phi(t_0, t)$ is the state transition matrix.] At the opposite extreme, when the r_k values constitute a random sequence, the above stability criterion must be averaged, i.e., $\langle \pi(1 - r_k) \rangle < 1$. If, in addition, the r_k are uncorrelated, $\langle \pi(1 - r_k) \rangle = 1 - \langle r_k \rangle$, the stability is guaranteed when $\langle r_k \rangle < 2$.

LITERATURE CITED

- Arnold, V. I., and A. Avez. 1970. Ergodic problems in classical mechanics. Benjamin, New York.
- Auslander, D., G. F. Oster, and C. Huffaker. 1974. Dynamics of interacting populations. *J. Franklin Inst.* 297:345-375.
- Baumol, W. J. 1970. Economic dynamics. 3d ed. Macmillan, New York.
- Beddington, J. R. 1974. Age distribution and the stability of simple discrete time population models. *J. Theoret. Biol.* 47:65-74.
- Beddington, J. R., C. A. Free, and J. H. Lawton. 1975. Dynamic complexity in predator-prey models framed in difference equations. *Nature* 255:58-60.
- Chaundy, T. W., and E. Phillips. 1936. The convergence of sequences defined by quadratic recurrence-formulae. *Quart. J. Math. (Oxford)* 7:74-80.
- Clark, C. W. 1976. Mathematical bioeconomics. Wiley Interscience, New York.
- Cook, L. M. 1965. Oscillation in the simple logistic growth model. *Nature* 207:316.
- Diamond, P. 1976. Chaotic behavior of systems of difference equations. *Int. J. Systems Sci.* (in press).
- Gilpin, M. E. 1975. Group selection in predator-prey communities. Princeton University Press, Princeton, N.J.
- Guckenheimer, J. 1970. Endomorphisms of the Riemann sphere. *Proc. Amer. Math. Soc. Symp. Pure Math.* 14:95-124.
- Guckenheimer, J., G. Oster, and A. Ipaktchi. 1976. The dynamics of density dependent population models. *Theoret. Pop. Biol.* (in press).
- Hassell, M. P. 1974. Density dependence in single species populations. *J. Anim. Ecol.* 44:283-296.
- Hassell, M. P., and H. N. Comins. 1976. Discrete time models for two-species competition. *Theoret. Pop. Biol.* (in press).
- Hassell, M. P., J. H. Lawton, and R. M. May. 1976. Patterns of dynamical behavior in single species populations. *J. Anim. Ecol.* (in press).
- Hirsch, M. W., and S. Smale. 1974. Differential equations, dynamical systems, and linear algebra. Academic Press, New York.
- Krebs, C. J. 1972. Ecology: the experimental analysis of distribution and abundance. Harper & Row, New York.
- Leslie, P. H. 1957. An analysis of the data for some experiments carried out by Gause with populations of the protozoa, *Paramecium aurelia* and *P. caudatum*. *Biometrika* 44:314-327.
- Li, T.-Y., and J. A. Yorke. 1975. Period three implies chaos. *Amer. Math. Monthly* 82:985-992.
- Macfadyen, A. 1963. Animal ecology: aims and methods. 2d ed. Pitman, London.
- May, R. M. 1972. On relationships among various types of population models. *Amer. Natur.* 107:46-57.
- . 1974a. Biological populations with nonoverlapping generations: stable points, stable cycles, and chaos. *Science* 186:645-647.

- . 1974b. Ecosystem patterns in randomly fluctuating environments. Pages 1–50 in R. Rosen and F. Snell, eds. *Progress in theoretical biology*. Academic Press, New York.
- . 1975. Biological populations obeying difference equations: stable points, stable cycles, and chaos. *J. Theoret. Biol.* 49:511–524.
- . 1976. Simple mathematical models with very complicated dynamics. *Nature* (in press).
- May, R. M., G. R. Conway, M. P. Hassell, and T. R. E. Southwood. 1974. Time delays, density dependence, and single species oscillations. *J. Anim. Ecol.* 43:747–770.
- Maynard Smith, J. 1968. *Mathematical ideas in biology*. Cambridge University Press, Cambridge.
- . 1974. *Models in ecology*. Cambridge University Press, Cambridge.
- Moran, P. A. P. 1950. Some remarks on animal population dynamics. *Biometrics* 6:250–258.
- Oster, G. F., D. Auslander, and J. Guckenheimer. 1976. Deterministic and stochastic effects of population dynamics. Unpublished manuscript.
- Oster, G. F., and J. Guckenheimer. 1976. Bifurcation phenomena in population models. In J. Marsden, ed. *The Hopf bifurcation*. Springer-Verlag Lecture Notes in Mathematics, New York.
- Oster, G. F., and I. Rocklin. 1976. Population genetics and bifurcations. Unpublished manuscript.
- Oster, G. F., and Y. Takahashi. 1974. Models for age-specific interactions in a periodic environment. *Ecol. Monogr.* 44:483–501.
- Pennycuik, C. J., R. M. Compton, and L. Beckingham. 1968. A computer model for simulating the growth of a population, or of two interacting populations. *J. Theoret. Biol.* 18:316–329.
- Ricker, W. E. 1954. Stock and recruitment. *J. Fisheries Res. Board Can.* 11:559–623.
- Ruelle, D., and F. Takens. 1971. On the nature of turbulence. *Commun. Math. Phys.* 20:167–192.
- Samuelson, P. A. 1942. The stability of equilibrium: linear and nonlinear systems. *Econometrica* 10:1–25.
- . 1947. *Foundations of economic analysis*. Harvard University Press, Cambridge, Mass. pp. 390.
- Skellam, J. G. 1951. Random dispersal in theoretical populations. *Biometrika* 38:196–218.
- Slatkin, M. 1970. Selection and polygenic characters. *Proc. Nat. Acad. Sci.* 66:87–93.
- Smale, S. 1967. Differentiable dynamical systems. *Bull. Amer. Math. Soc.* 73:747–817.
- Smart, D. R. 1974. *Fixed point theorems*. Cambridge University Press, Cambridge.
- Southwood, T. R. E. 1975. The dynamics of insect populations. Pages 151–199 in D. Pimentel, ed. *Insects, science and society*. Academic Press, New York.
- Tuck, J. L., and M. T. Menzel. 1972. The superperiod of the nonlinear weighted string (FPU) problem. *Advance. Math.* 9:399–407.
- Ulam, S. M. 1963. Some properties of certain non-linear transformations. Pages 85–95 in S. Drobot, ed. *Mathematical models in physical sciences*. Prentice-Hall, Englewood Cliffs, N.J.
- Usher, M. B. 1972. Developments in the Leslie matrix model. Pages 29–60 in J. N. R. Jeffers, ed. *Mathematical models in ecology*. Blackwell, Oxford.
- Utida, S. 1957. Population fluctuation, an experimental and theoretical approach. *Cold Spring Harbor Sympos. Quant. Biol.* 22:139–151.
- . 1967. Damped oscillation of population density at equilibrium. *Res. Pop. Ecol.* 9:1–9.
- Varley, G. C., G. R. Gradwell, and M. P. Hassell. 1973. *Insect population ecology*. Blackwell, Oxford.
- Watt, K. E. F. 1968. *Ecology and resource management (and references therein)*. McGraw-Hill, New York.
- Williamson, M. 1972. *The analysis of biological populations*. Arnold, London.
- . 1974. The analysis of discrete time cycles. Pages 17–33 in M. B. Usher and M. Williamson, eds. *Ecological stability*, Chapman & Hall, London.