



CLOAKING: Where Science meets Science Fiction

Many Collaborators:

- **Nicolae Nicorovici (Sydney)**
- **Ross McPhedran (Sydney)**
- **Lindsay Botten (Sydney)**
- **Mark Briane (Rennes)**
- **John Willis (Cambridge)**
- **Wenshan Cai (Purdue)**
- **Uday Chettiar (Purdue)**
- **Alexander Kildishev (Purdue)**
- **Vladimir Shalaev (Purdue)**
- **Zubin Jacob (Purdue)**
- **Kirill Cherednichenko (Bath)**
- **Fernando Guevara Vasquez (Utah)**
- **Daniel Onofrei (Utah)**

- **with thanks to Alexei Efros (Utah) for a key remark**

- **And a special thanks to Mary Alexander for masterfully putting the film clips together, and to Marcie Collett and John Patton for helping orchestrate this**

- **Supported by the National Science Foundation**

H.G. Wells (1897)

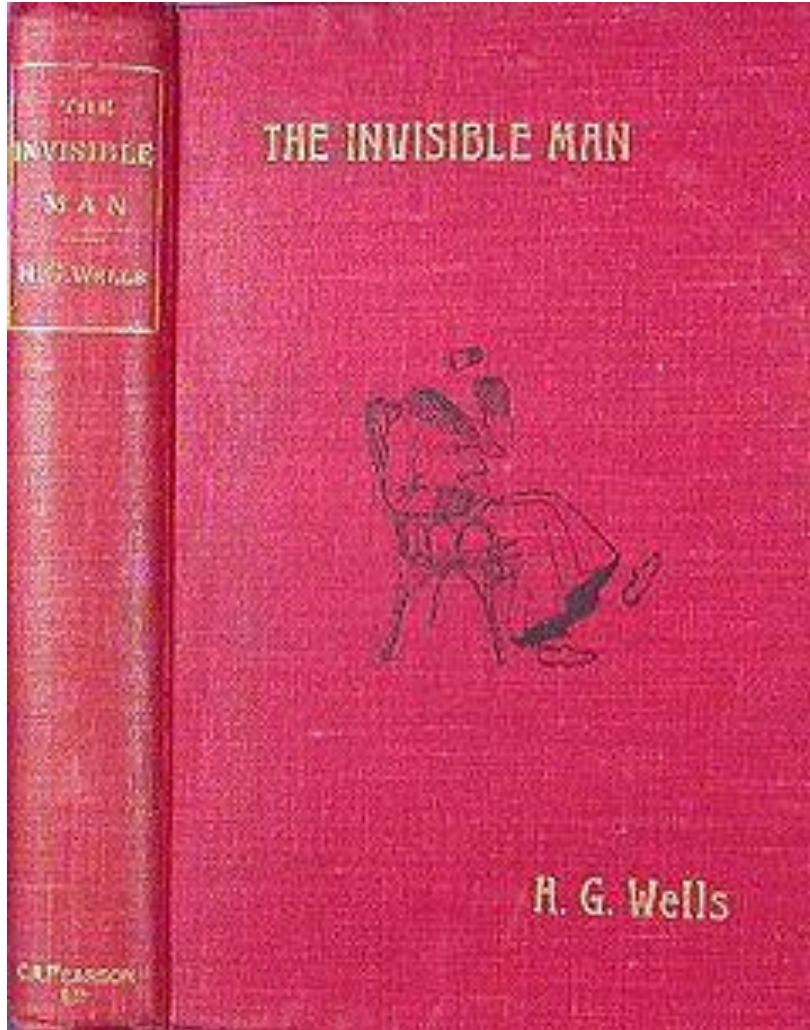

Becomes invisible by matching his refractive index to that of air



Fantastic Four (1961)

Makes herself invisible by mentally bending all wavelengths of light around her.

Star Trek: Cloaked Romulan Bird of Prey











The art of Beverly Doolittle

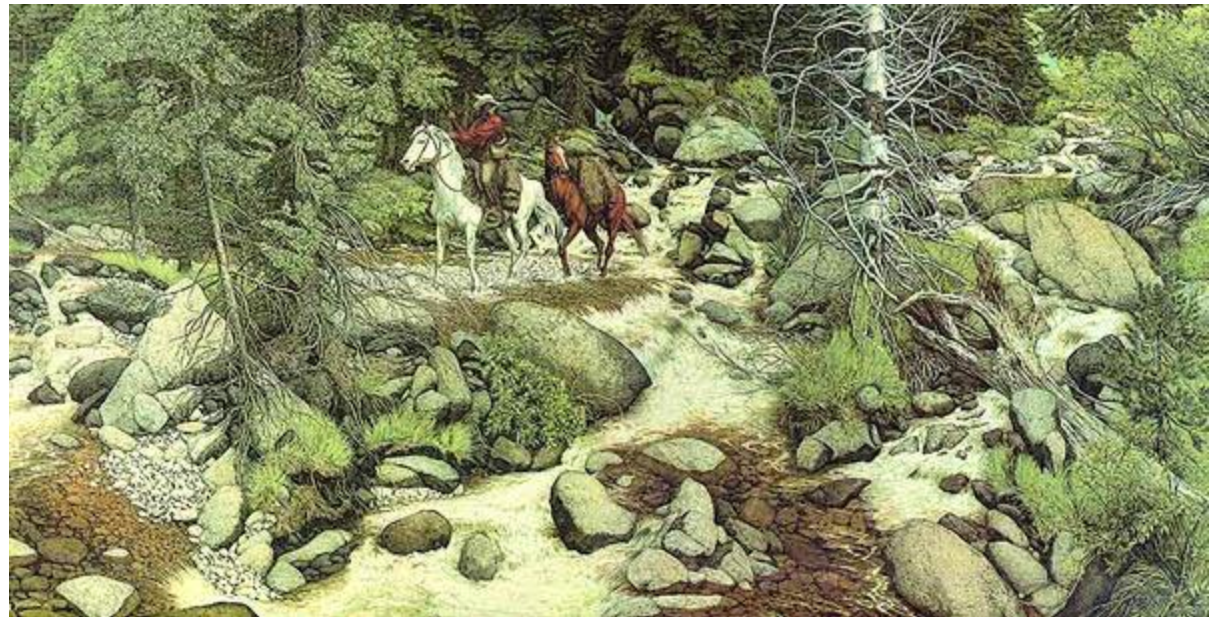
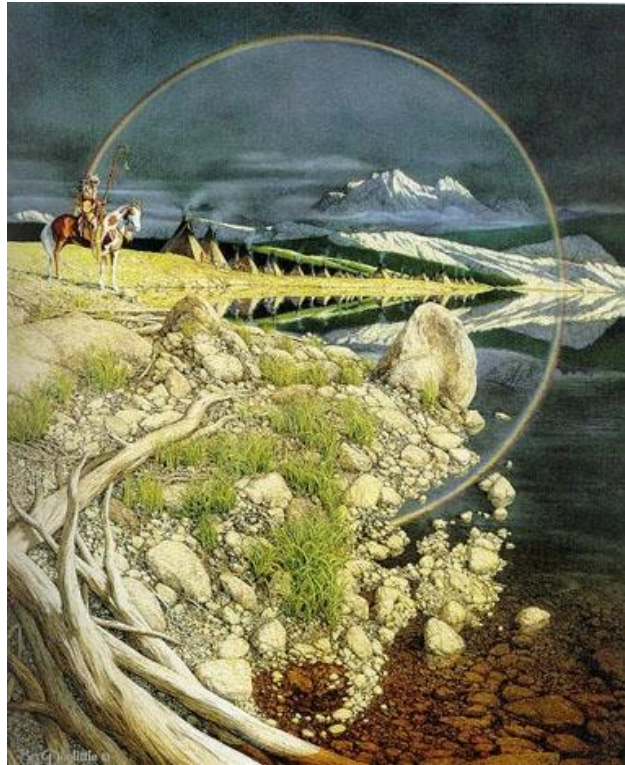
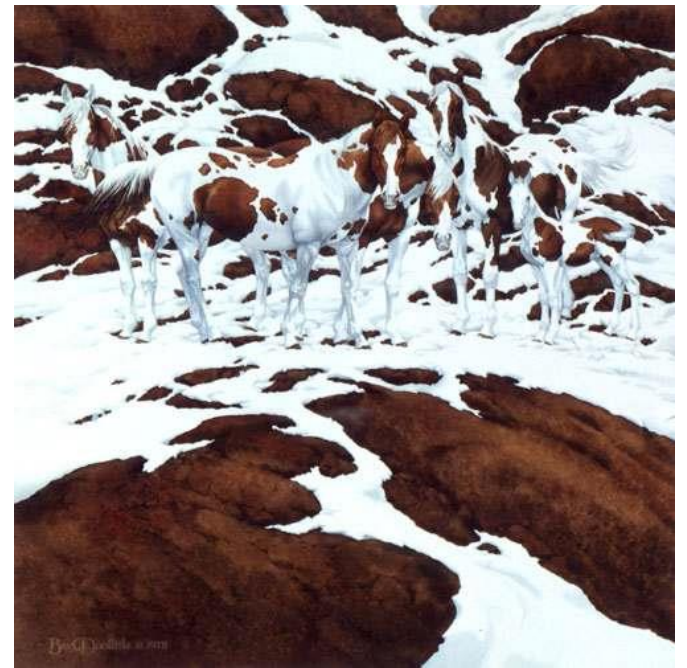
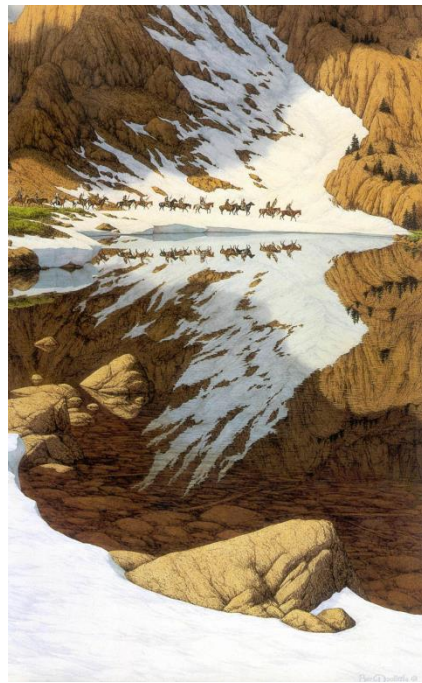

Camouflage Artist Liu Bolin



Camouflage by mirrors



Choi and Howell (2014)

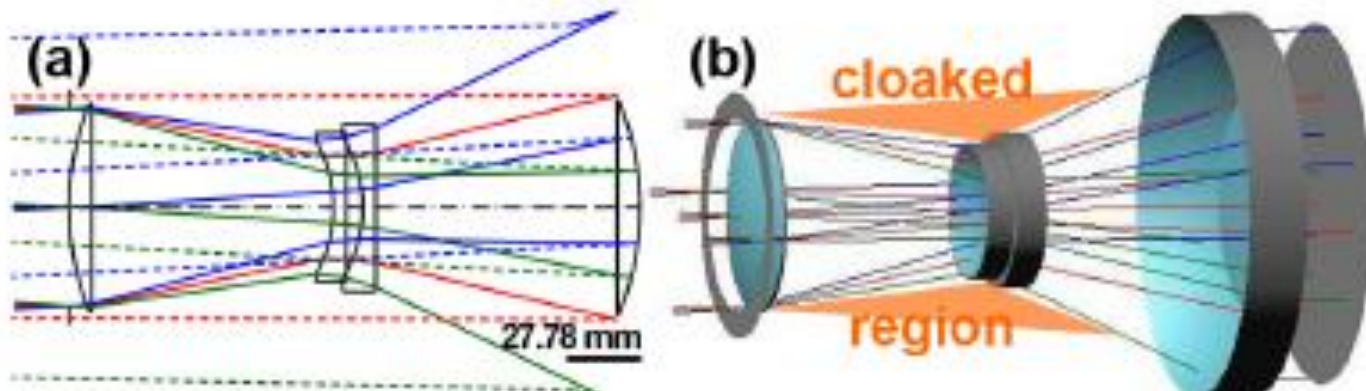
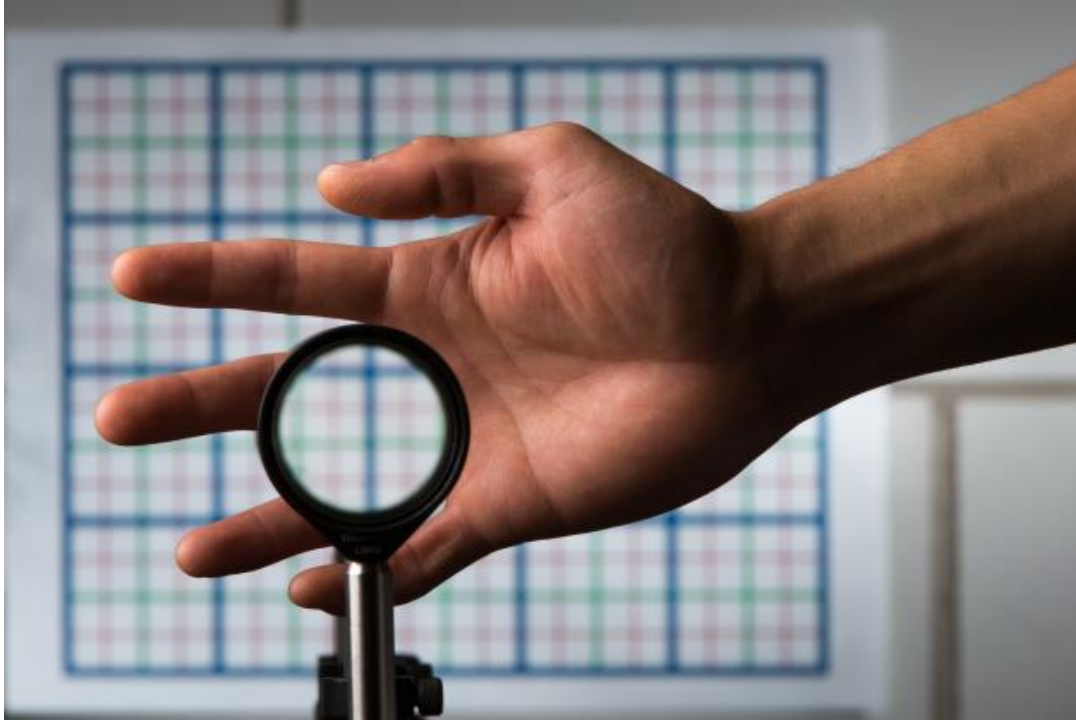



Invisibility cloak of Tachi and collaborators





Transparent Cockpit

Invisible Trains ?

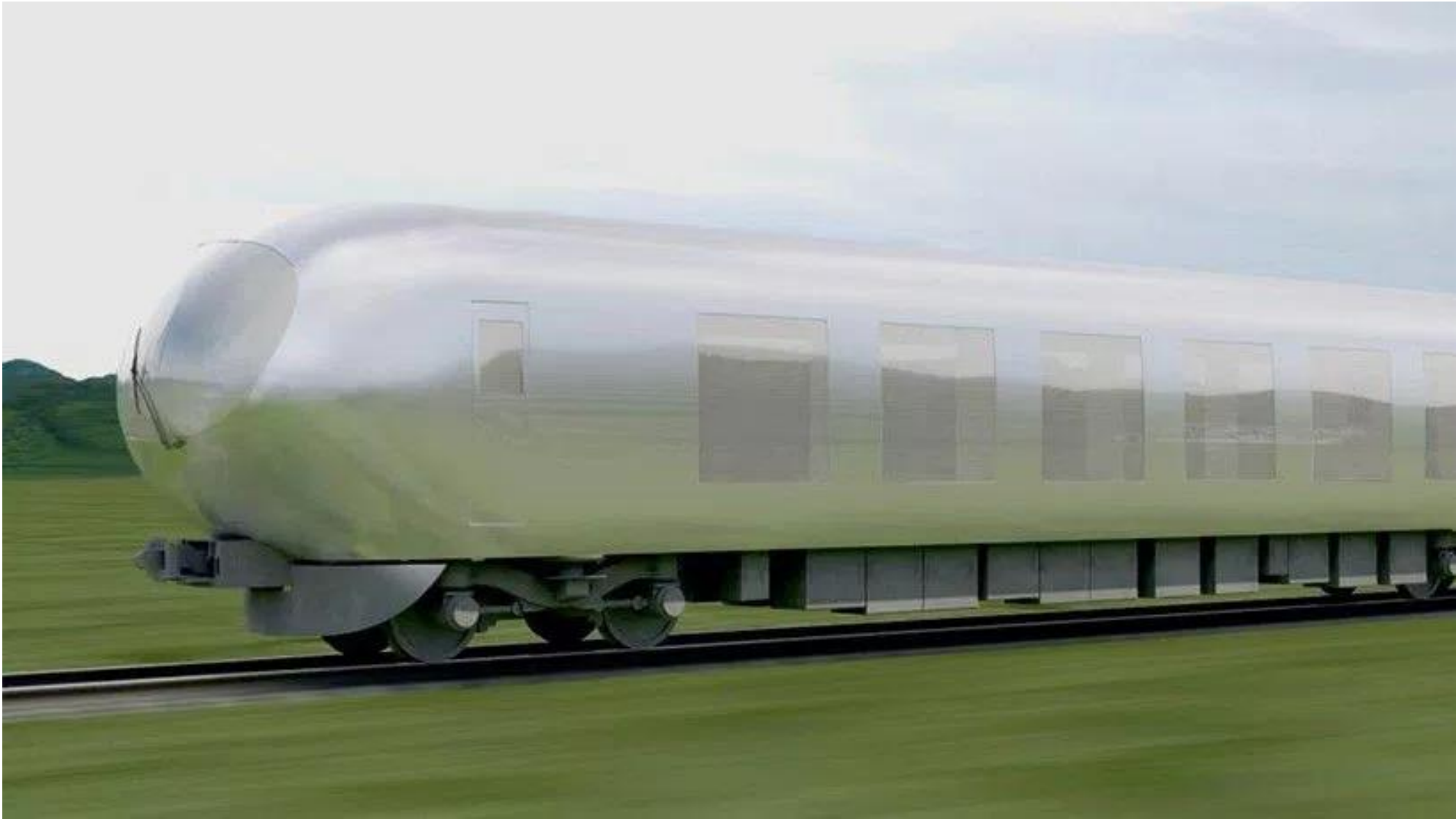



<http://www.saferplane.com/stealth/>



BAE ADAPTIV
Camouflage

Mirages:

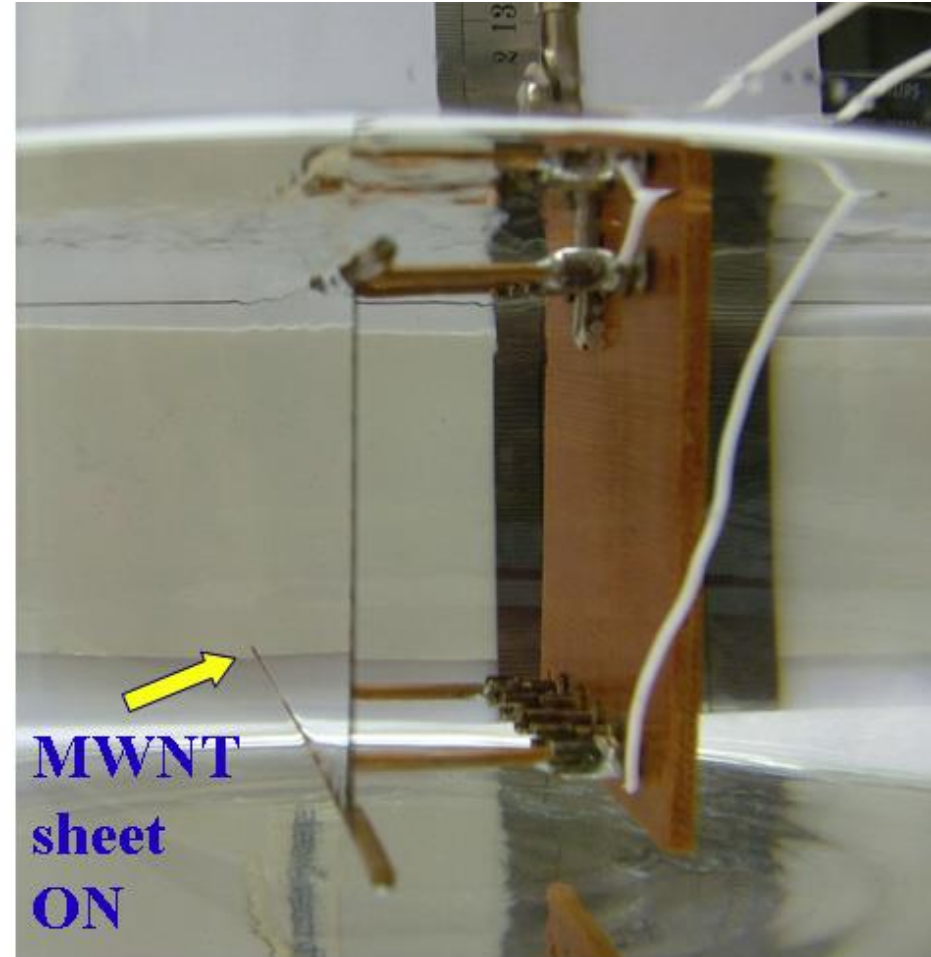
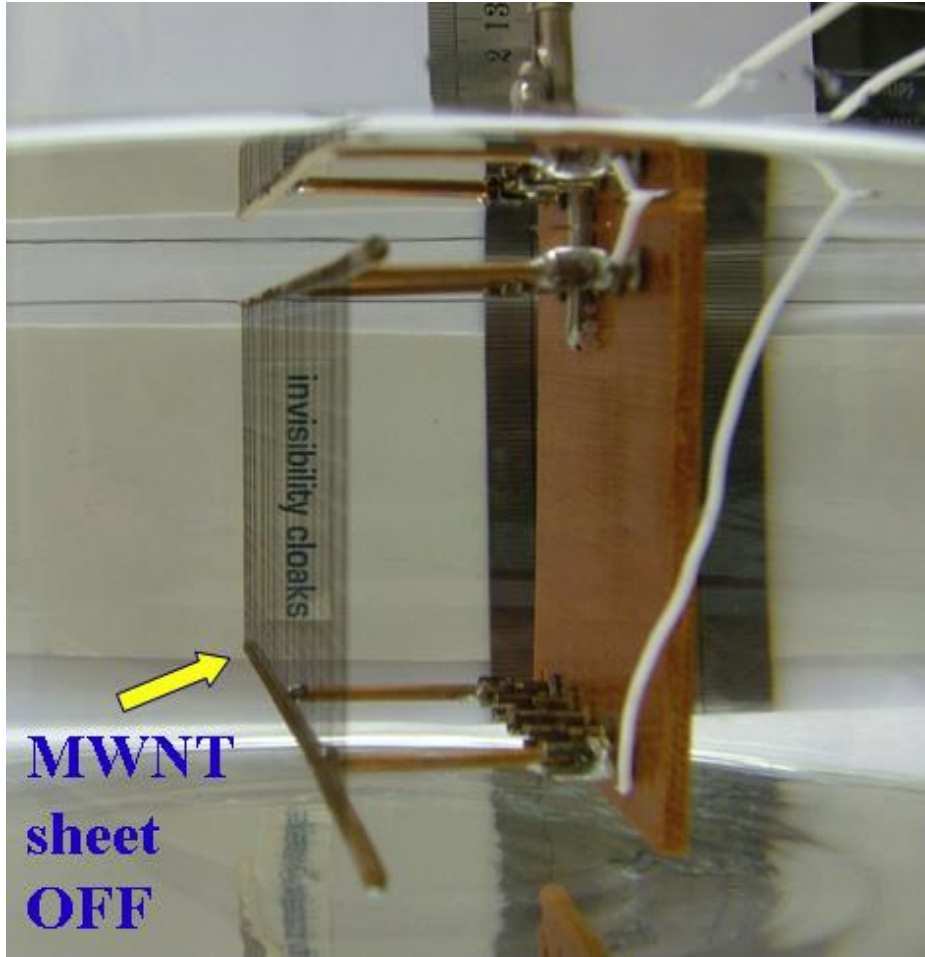

Aliev et.al. (2011)



Neutral Inclusions:
Invisibility to some fields.

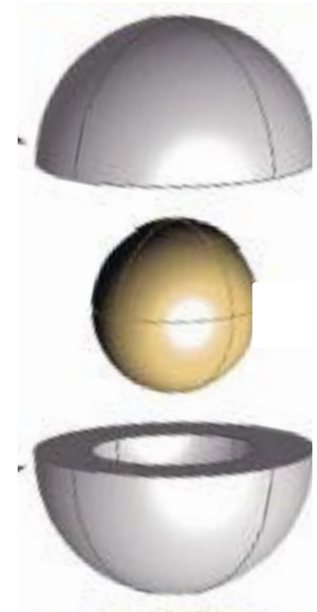
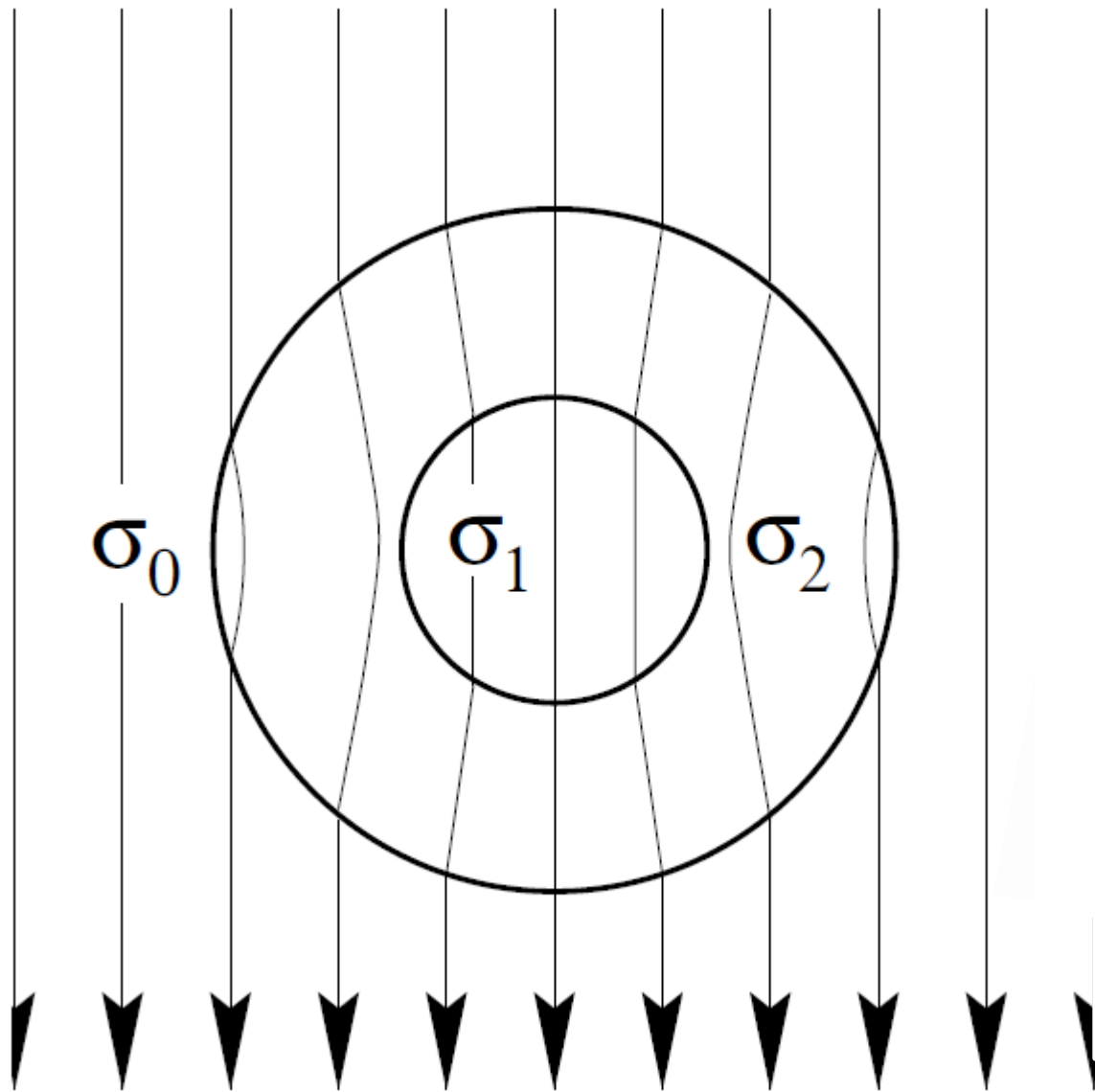

Alu and Engheta (2005)

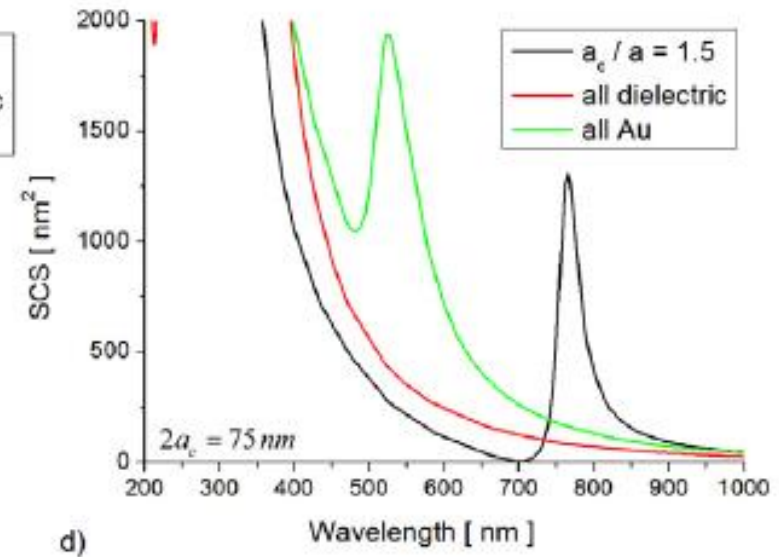
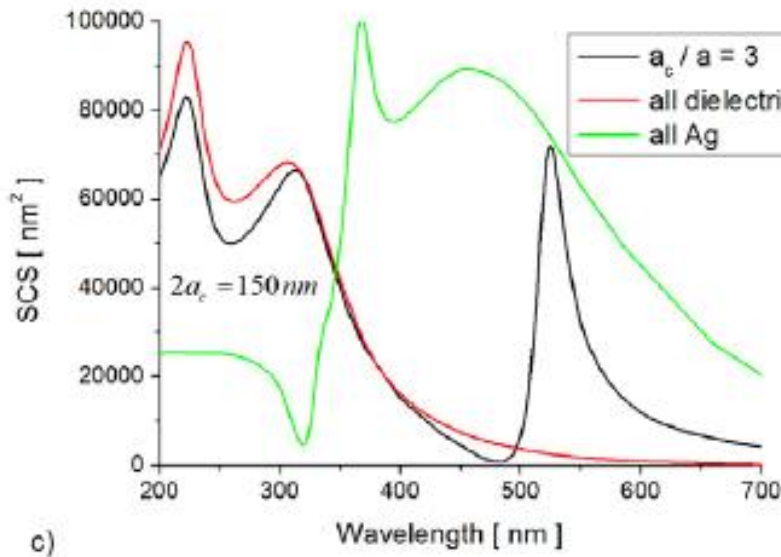
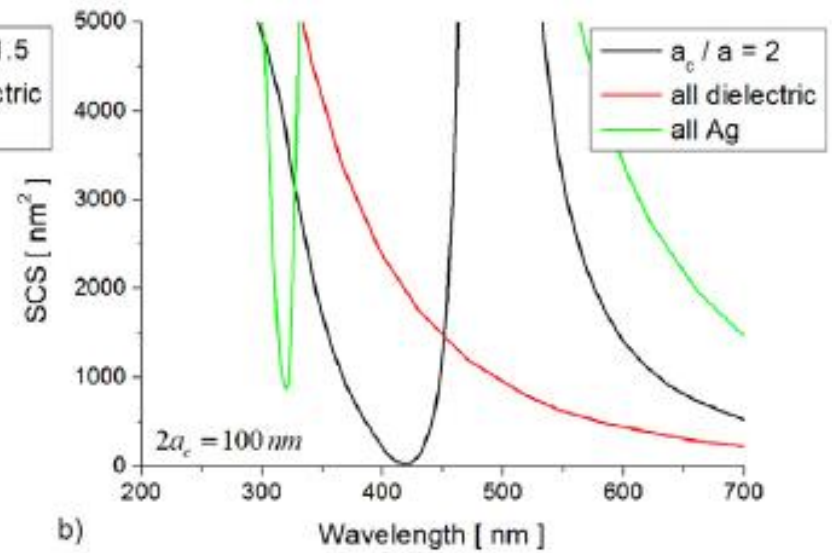
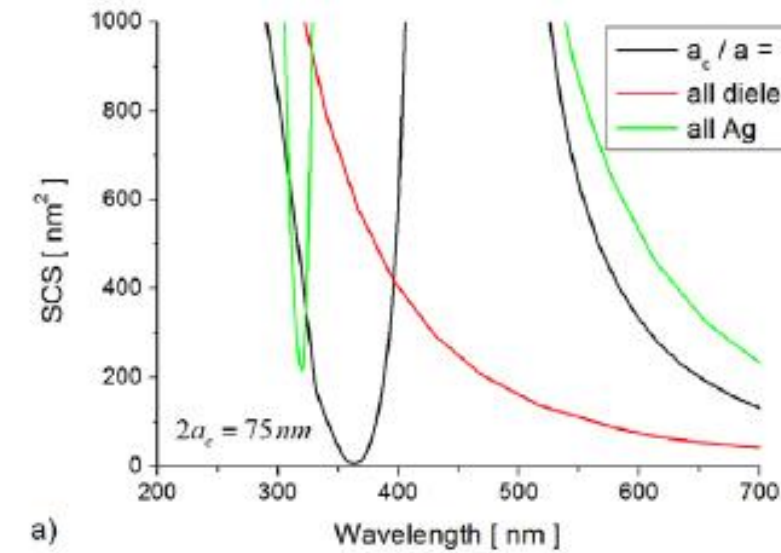

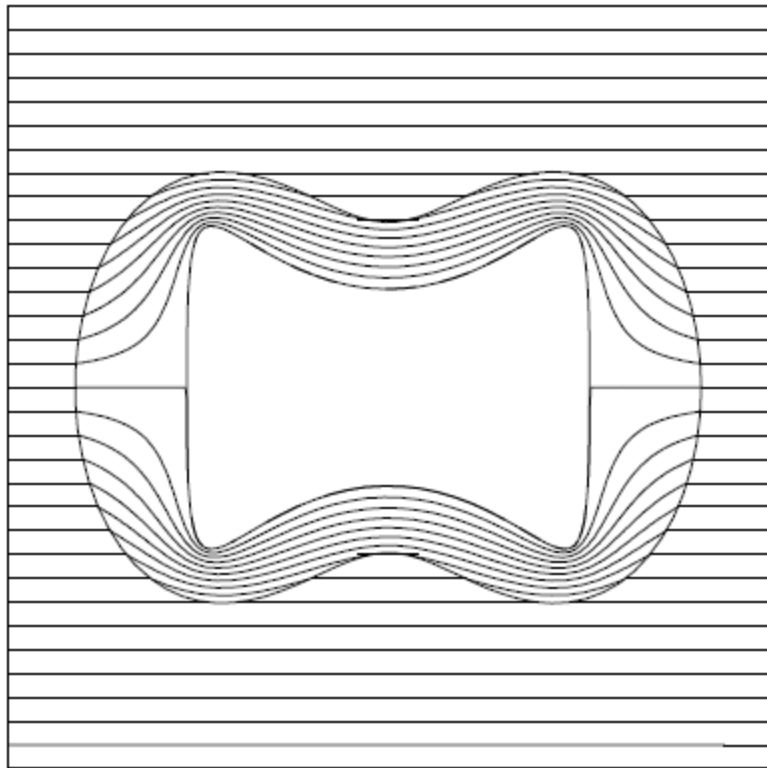

(a)

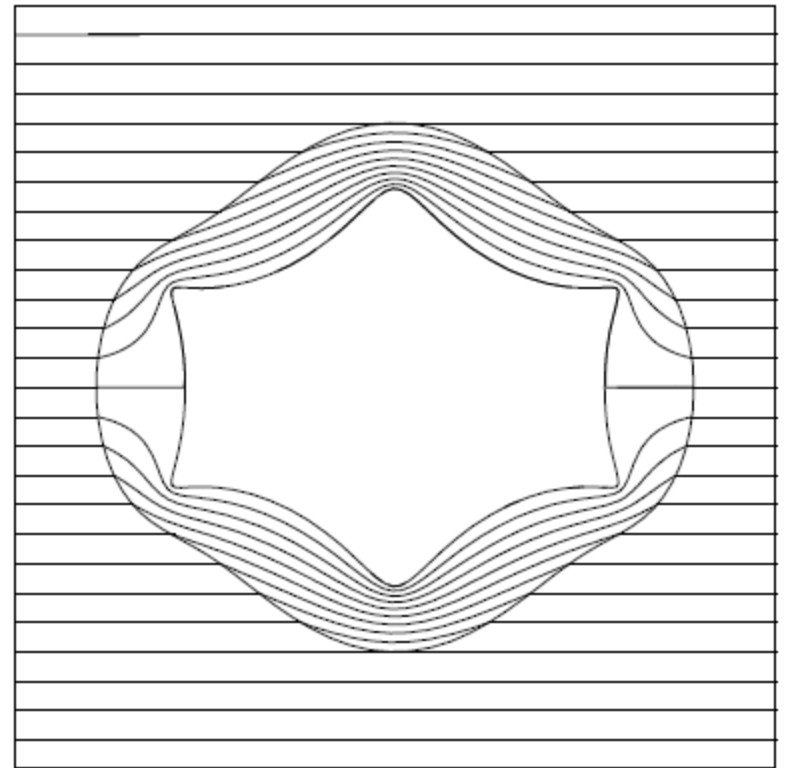

(b)

with S. Serkov (2001)

Cloak making an object “unfeelable”: Buckmann et. al. (2014)

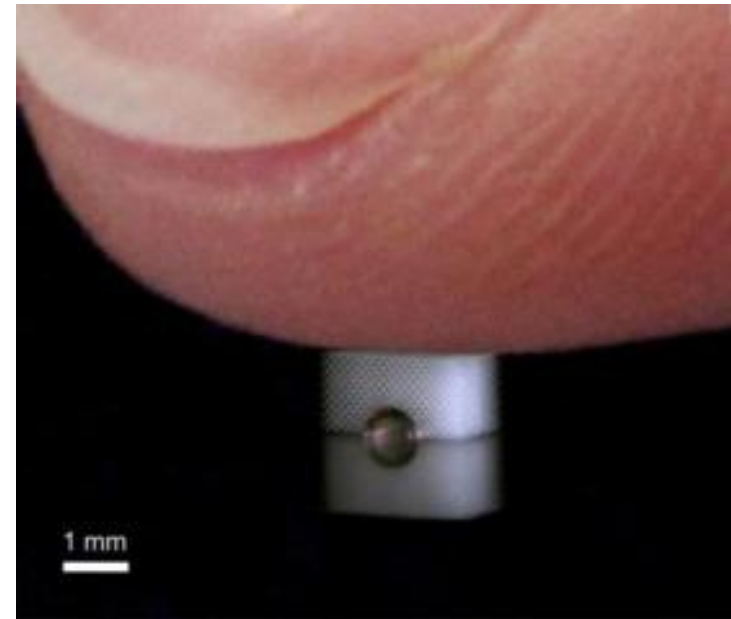
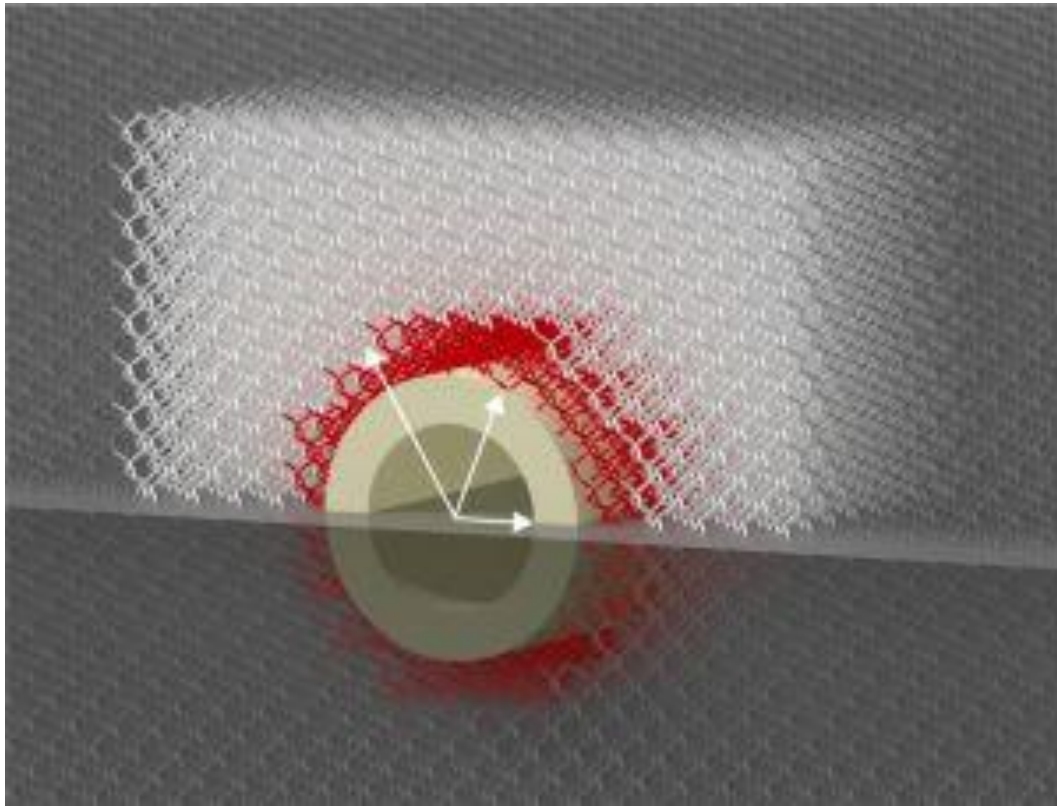

Pentamodes blueprint, with Cherkaev 1995 realized: Kadic et.al. 2012

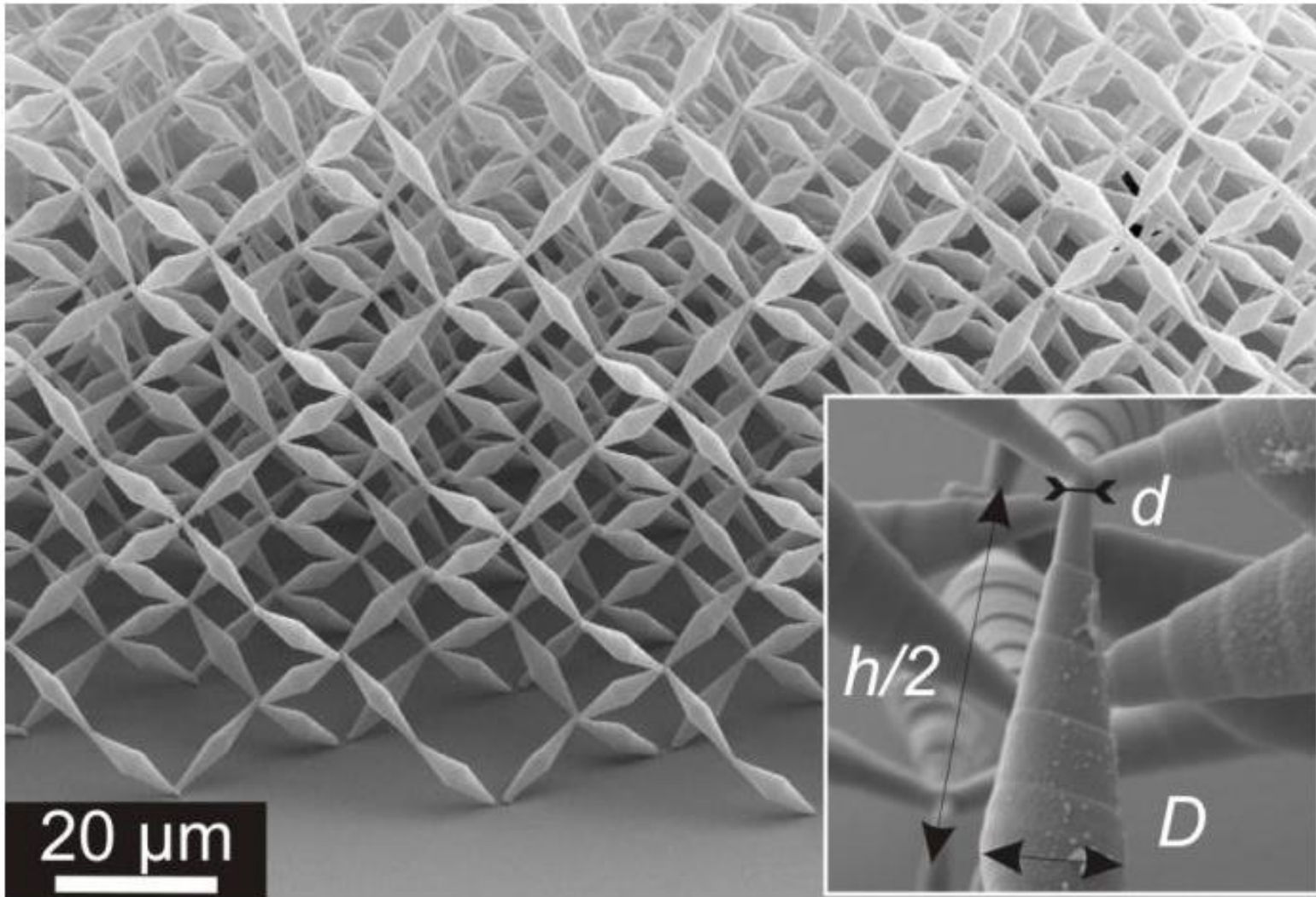

Multicoated cyclinders and spheres can be neutral to multipole fields up to a given order

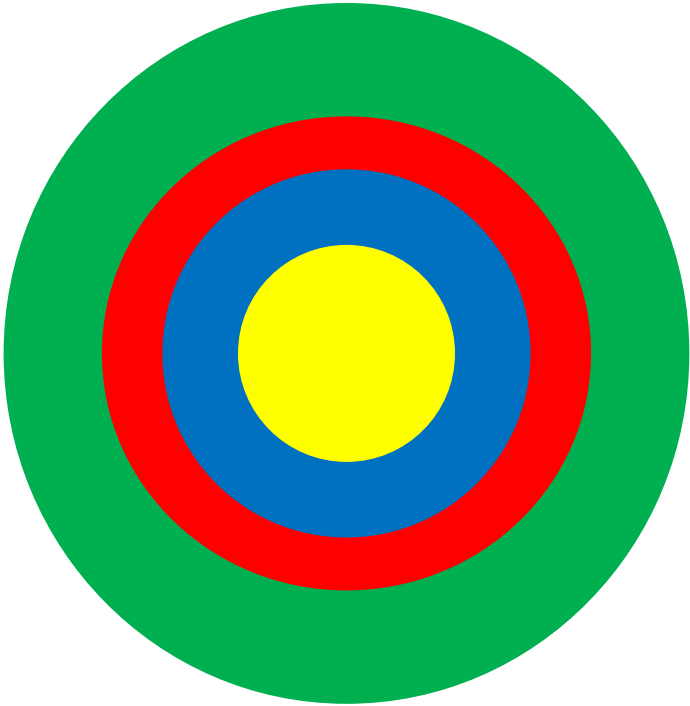

Conductivity: Ammari et. al. (2012)

Helmholtz: Ammari et. al. (2012)

Maxwell: Ammari et. al. (2013)

The simplest type of cloaking:
Cloaking for conductivity

Electrical Impedance Tomography: Cheney et. al. (1999)

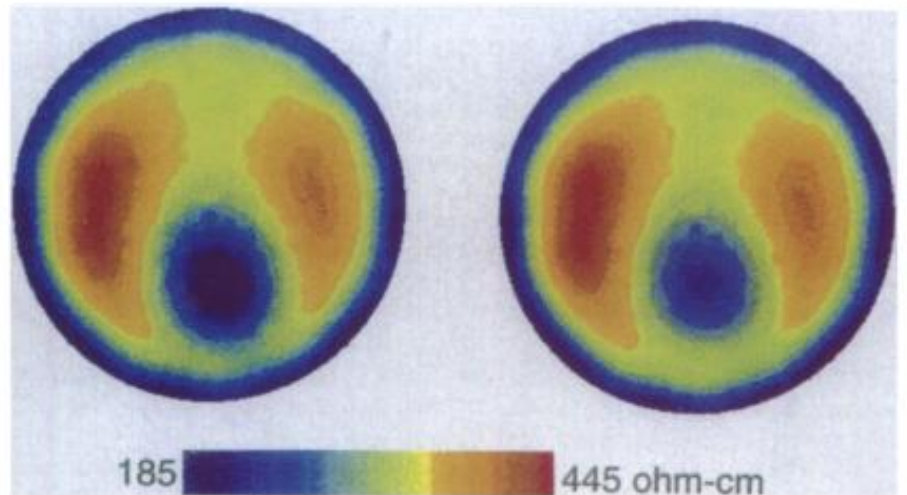
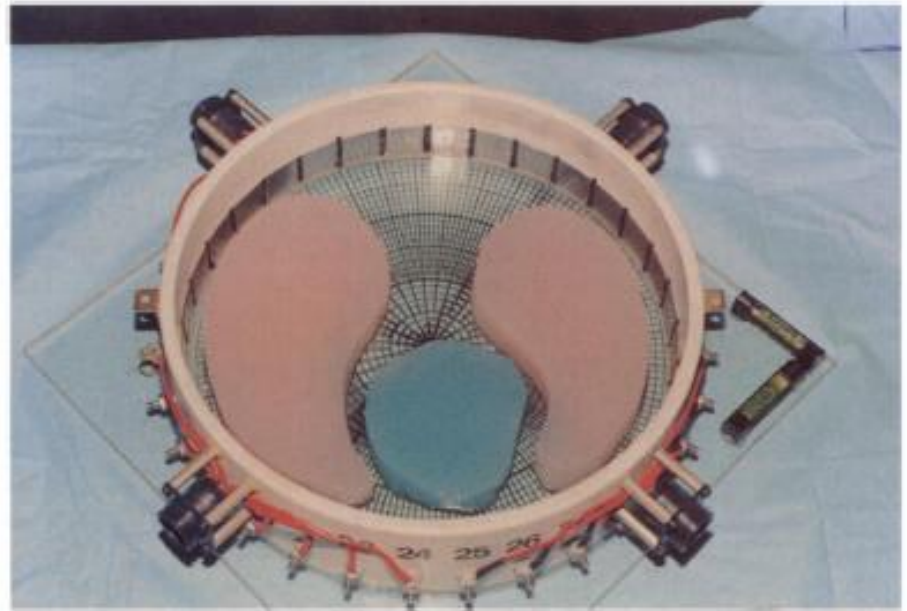

Transformation based cloaking

First discovered by Greenleaf, Lassas and Uhlmann (2003) for conductivity. Extended to 2-dimensional geometric optics by Leonhardt (2006) and to Maxwell's equations by Pendry, Schurig and Smith (2006).

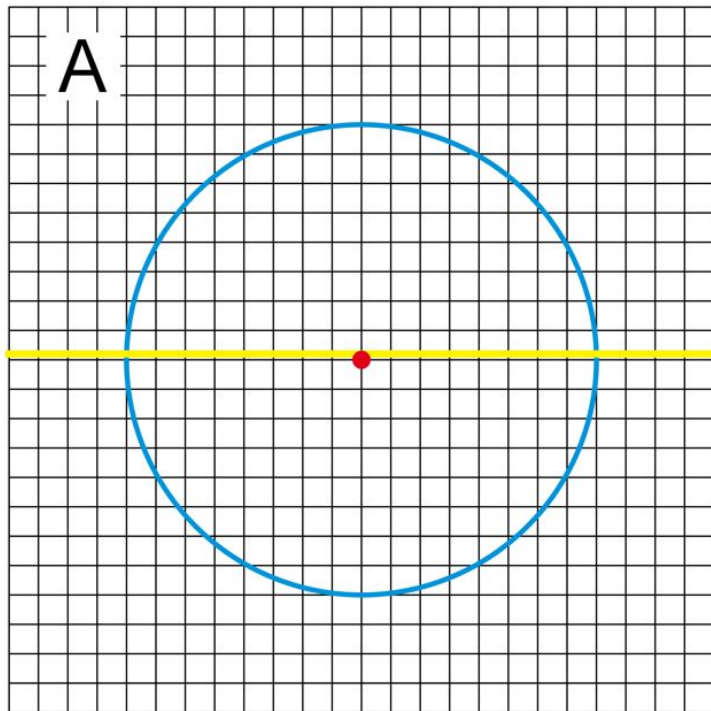

Stretching space

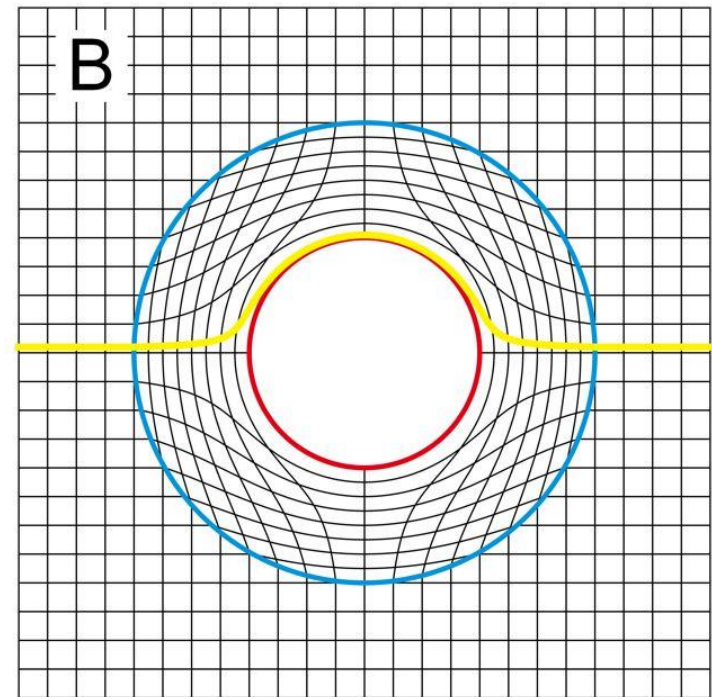

(From Ulf Leonhardt)

Transformation optics discovered: Dolin 1961

TO THE POSSIBILITY OF COMPARISON OF THREE-DIMENSIONAL ELECTROMAGNETIC SYSTEMS WITH NONUNIFORM ANISOTROPIC FILLING

L. S. Dolin

It was shown that it is possible to investigate three-dimensional systems with nonuniform anisotropic filling by comparison them with other, more simple three-dimensional systems. The examination is made basing on an invariance of Maxwels equations relative to the certain type of transformation of space metric and medium permeability and permittivity.

READ THE ABSTRACT ABOVE . IT IS EXACTLY TRANSFORMATION OPTICS.

$$R(r) \rightarrow r. \quad (4)$$

Коэффициенты Ламе этой системы равны $h_R = dr(R)/dR$, $h_\theta = r(R)$, $h_\varphi = r(R) \sin \theta$, и для проницаемостей среды получим следующие формулы:

$$\| \epsilon_{ik} \| = \| \mu_{ik} \| = \begin{vmatrix} \frac{R^2}{r^2(R)} \frac{dr(R)}{dR} & 0 & 0 \\ 0 & \frac{1}{dr(R)/dR} & 0 \\ 0 & 0 & \frac{1}{dr(R)/dR} \end{vmatrix}. \quad (5)$$

Translation Available
on my website

<http://www.math.utah.edu/~milton>

Never cited by Pendry, as far as I can see.

Cloaking for Waves

From Pendry, Schurig and Smith (2006)

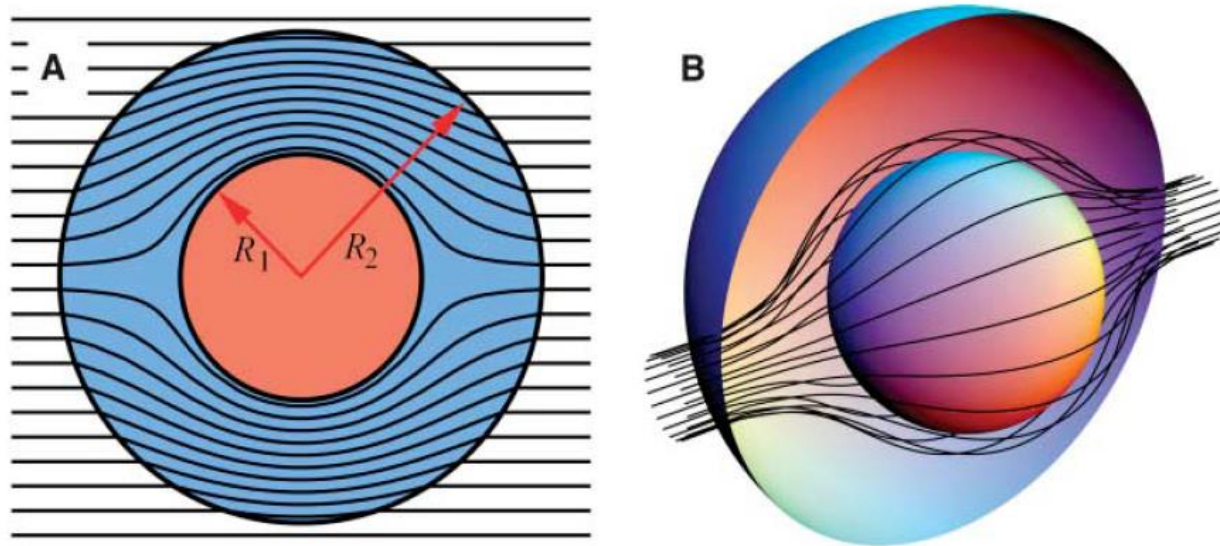

Putting an object in the orange cloaking region is equivalent to disturbing the medium inside a point in the equivalent problem, which will not disturb the surrounding fields, in particular outside the blue shell where the fields are the same.

Nicolet et. al. (2008)

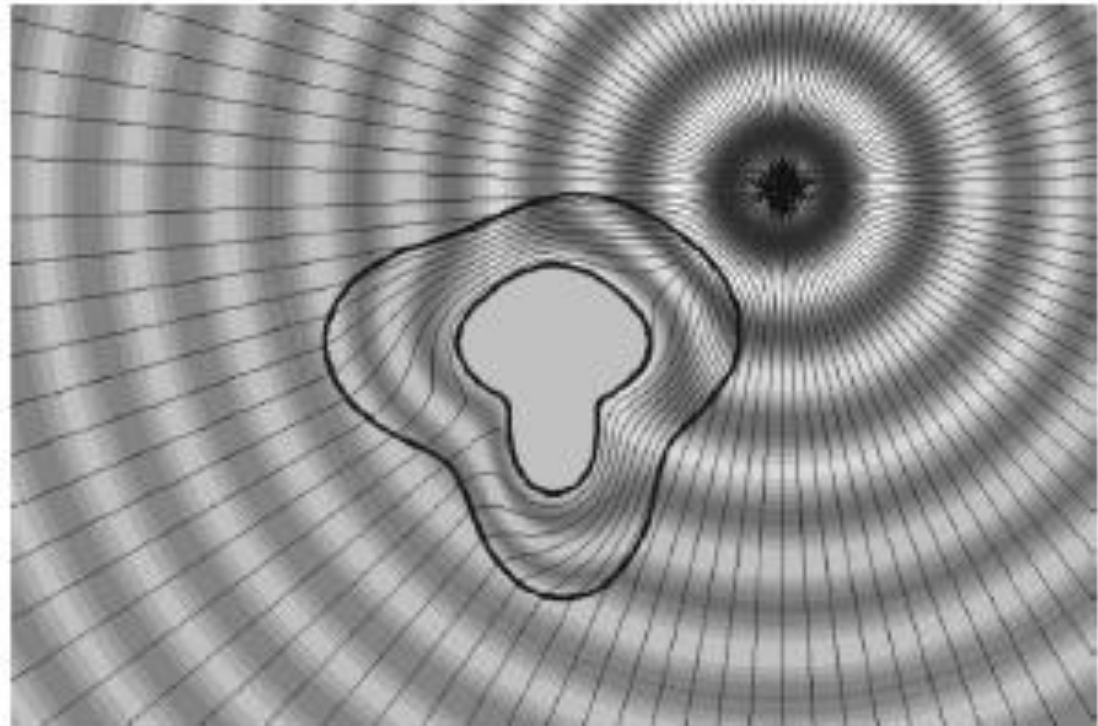
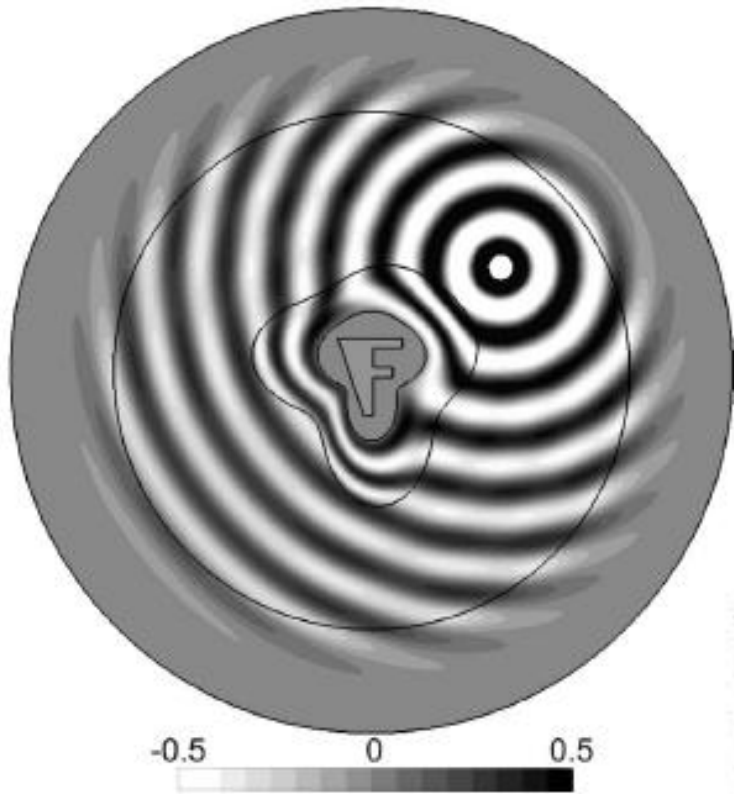

Experimental realization: Schurig, Mock,
Justice, Cummer, Pendry, Starr, Smith (2006)

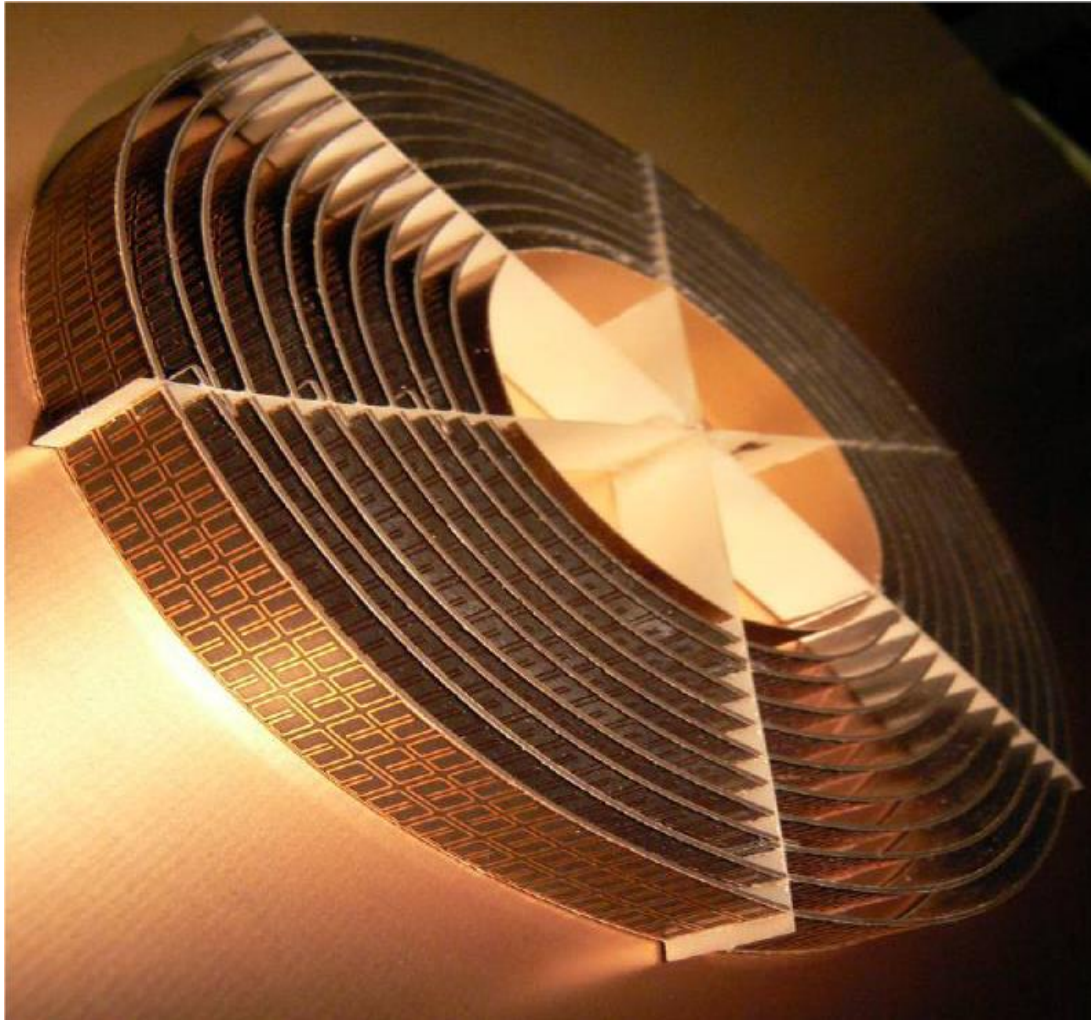

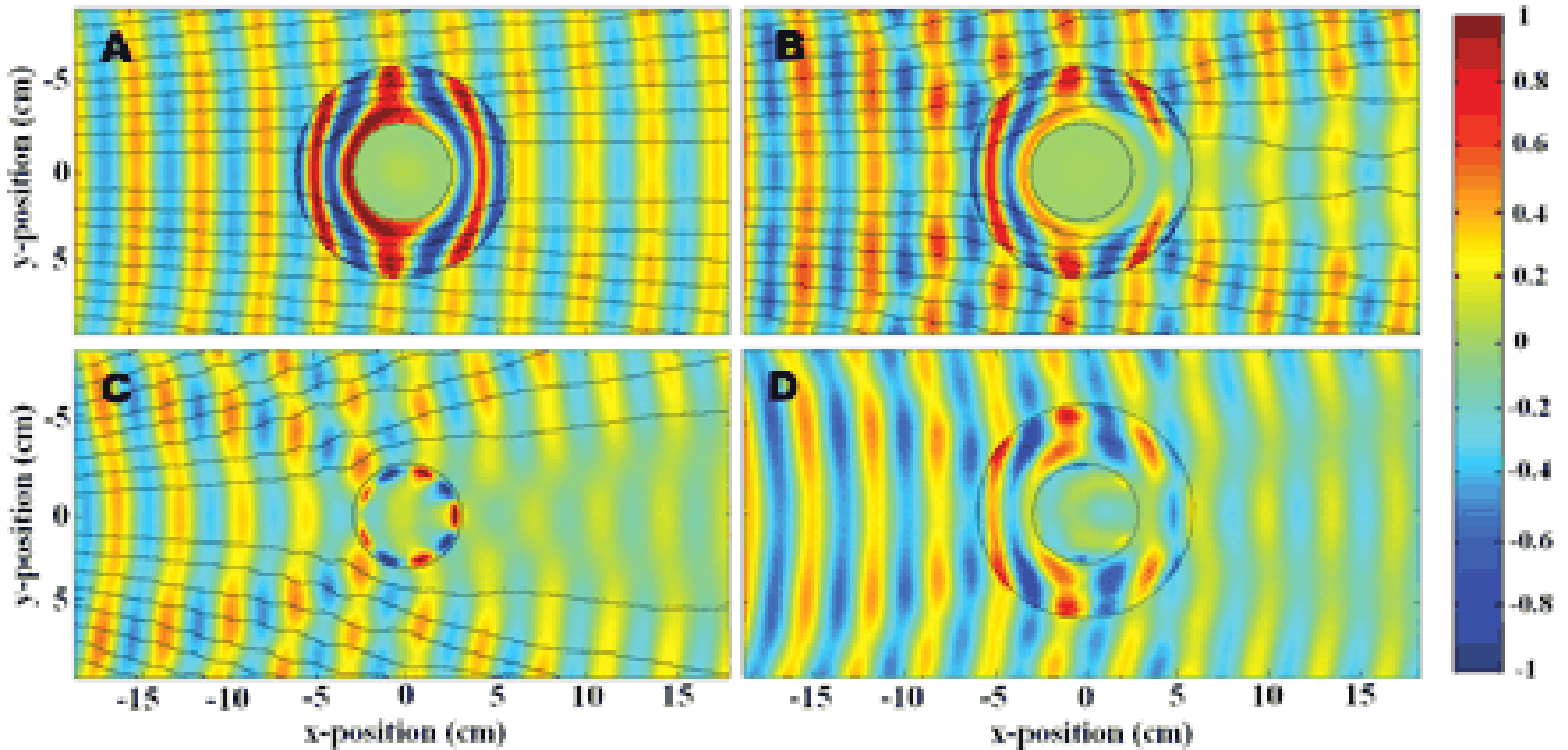

Approximate cloak in 2-dimensions

$$\epsilon_z = \left(\frac{b}{b-a}\right)^2 \quad \mu_r = \left(\frac{r-a}{r}\right)^2 \quad \mu_\theta = 1$$

With Cai, Chettiar, Kildishev and Shalaev

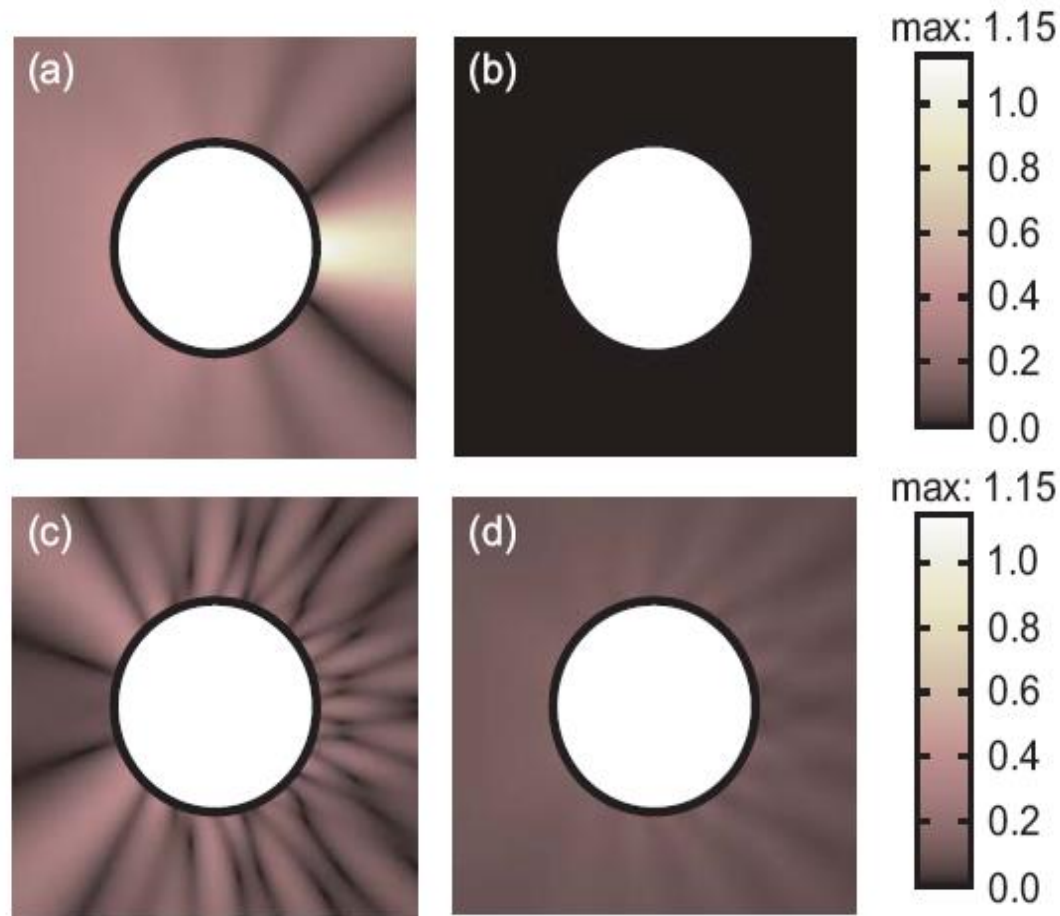

Approximate non-magnetic quadratic cloak with minimized reflectance

$$\varepsilon_r = \left(\frac{r'}{r}\right)^2; \quad \varepsilon_\theta = \left[p(2r' - b) + 1 - a/b\right]^{-2}; \quad \mu_z = 1. \quad p = a/b^2$$

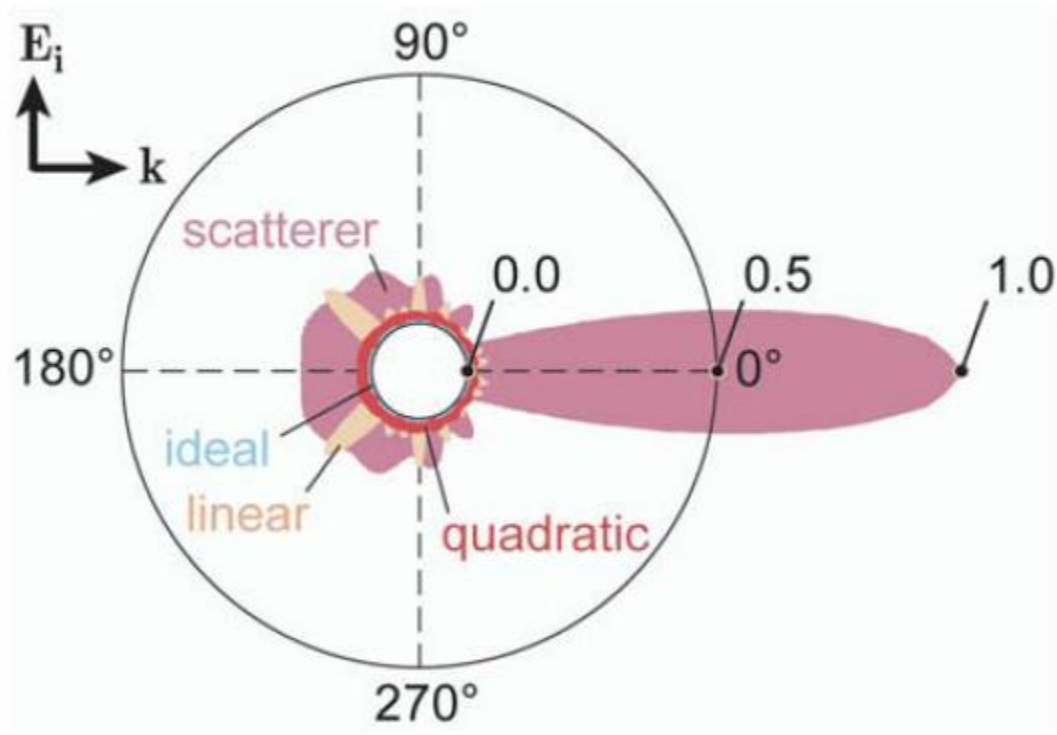

Scattering for the different approximate cloaks

Cloaking of water waves:

Farhat et. al. (2008)



With Cloak

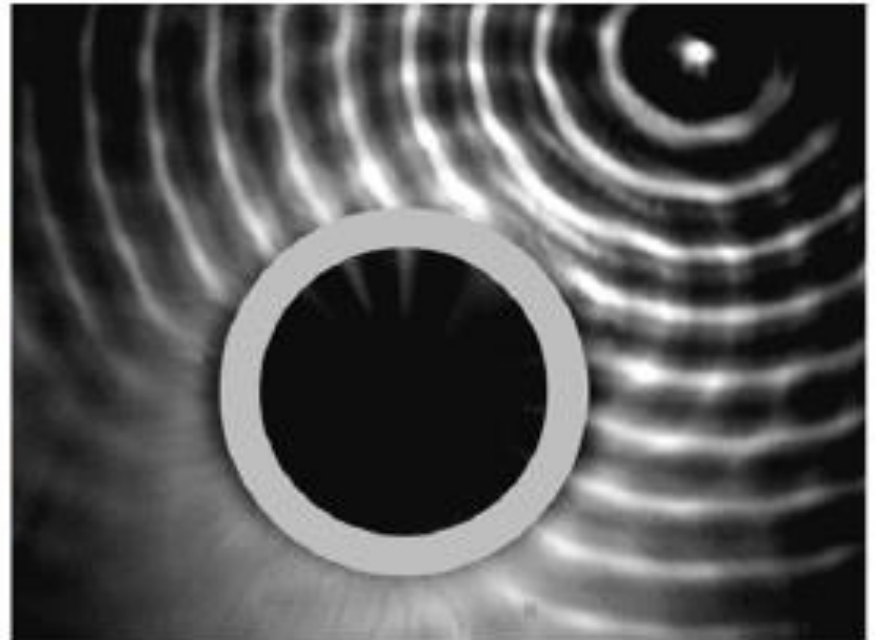

Without Cloak

Acoustic cloaking: Zhang, Zia, Fang (2011)

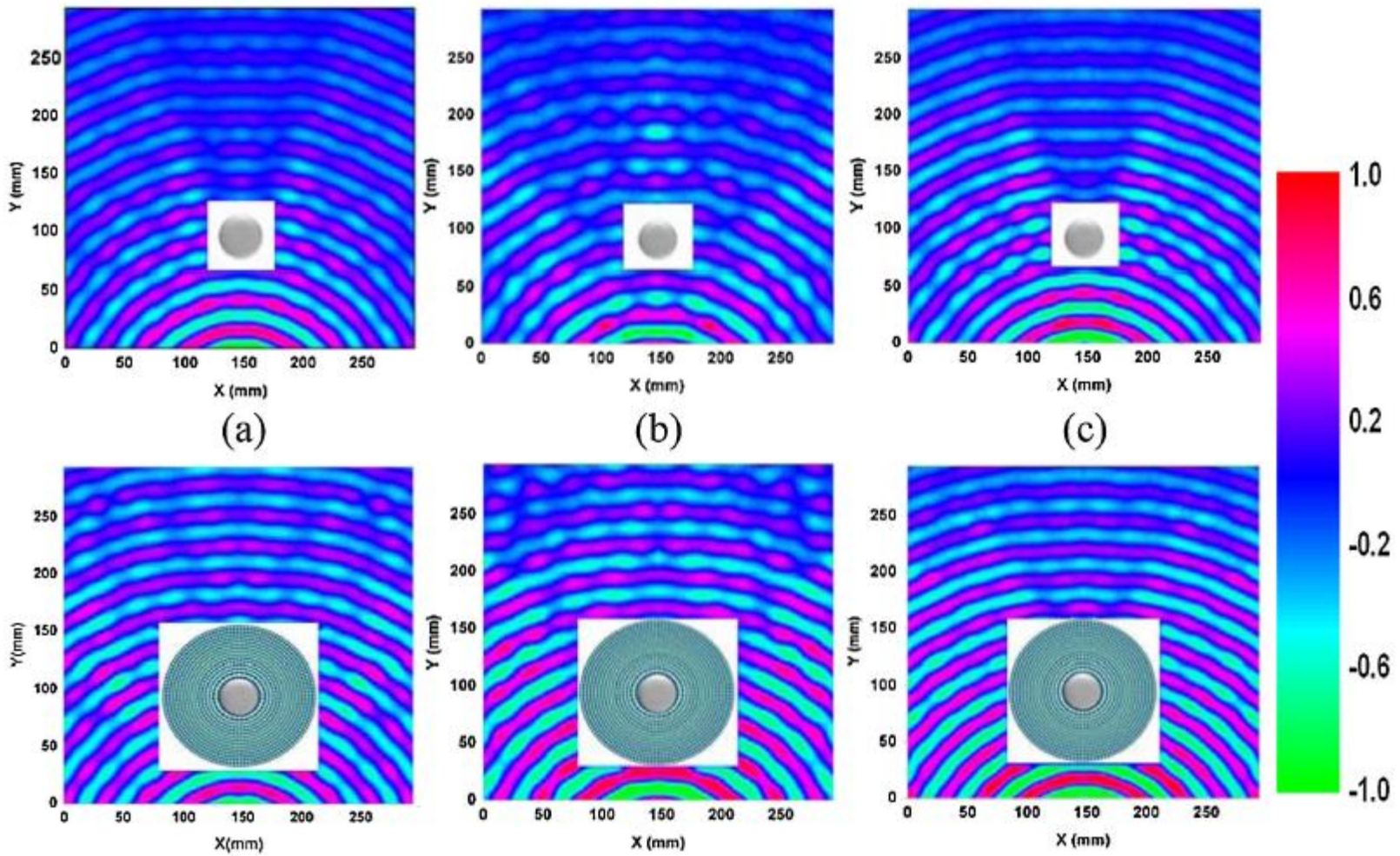
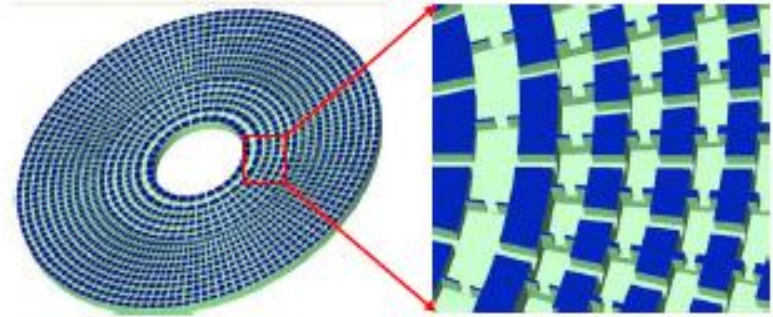

A different type of cloak

Hiding under the carpet:
Li and Pendry (2008)



A different type of cloak

Hiding under the carpet: Li and Pendry (2008)

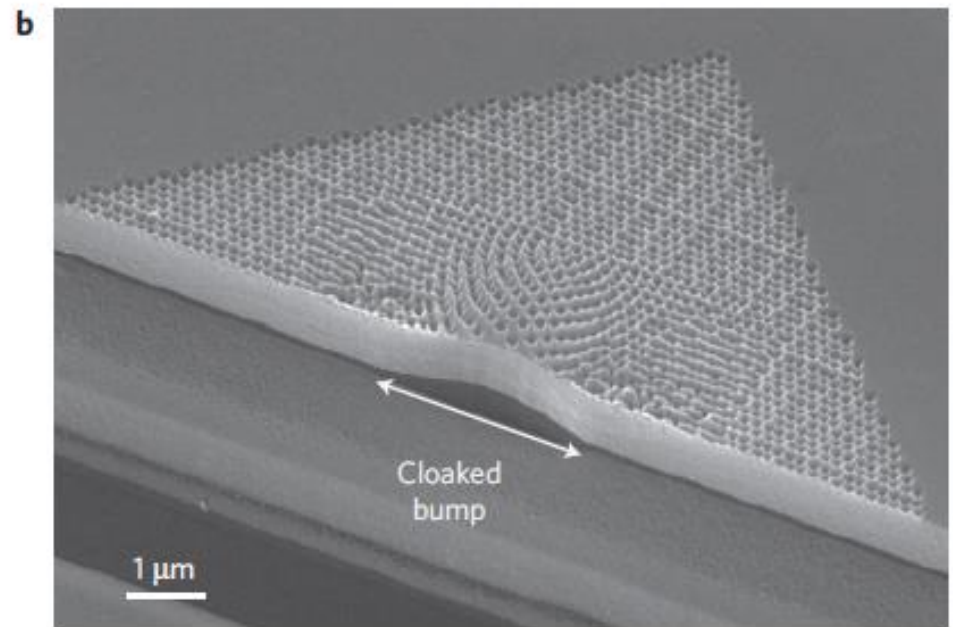
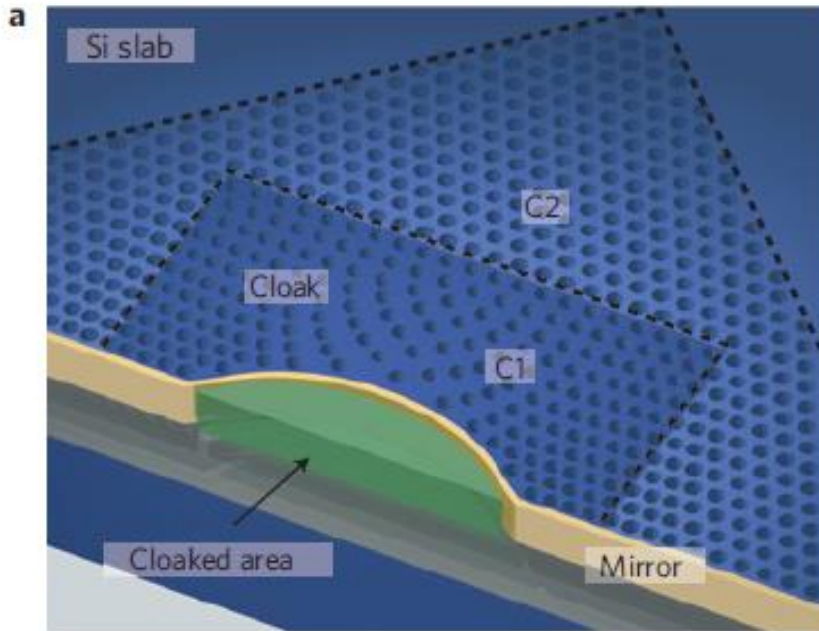

Experimental realization of Valentine et.al. 2009

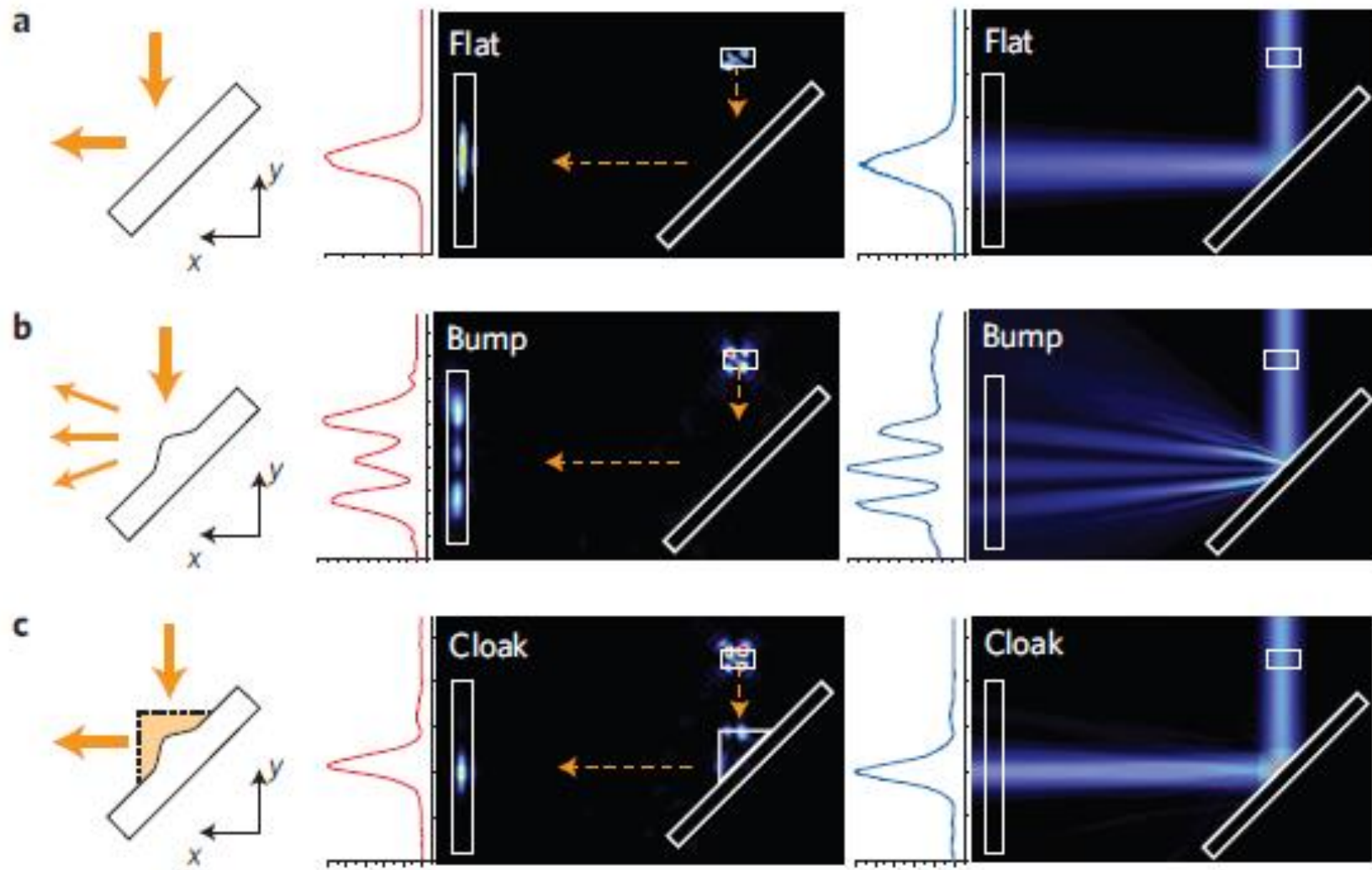

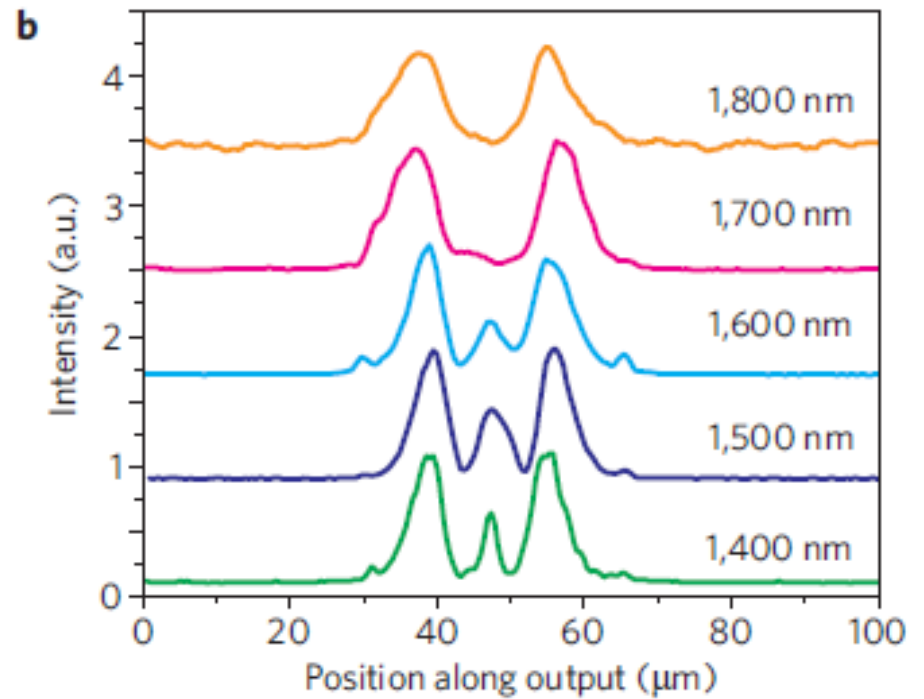
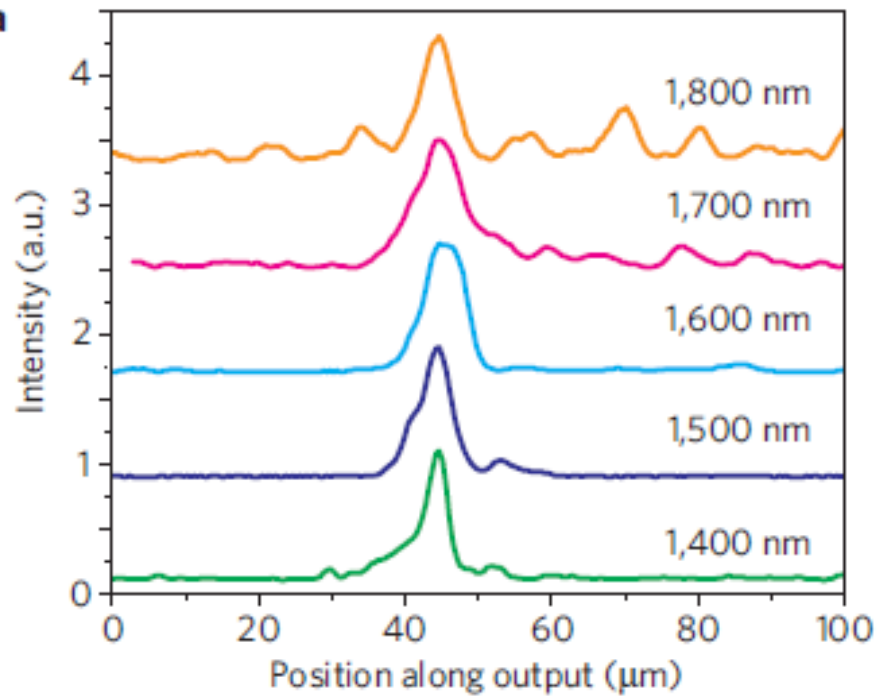

700nm=red light

Gabrielli et. al. (2009)

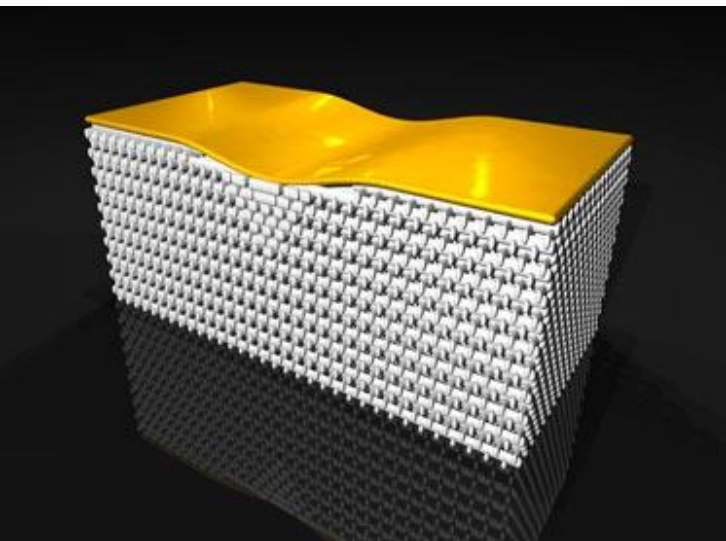
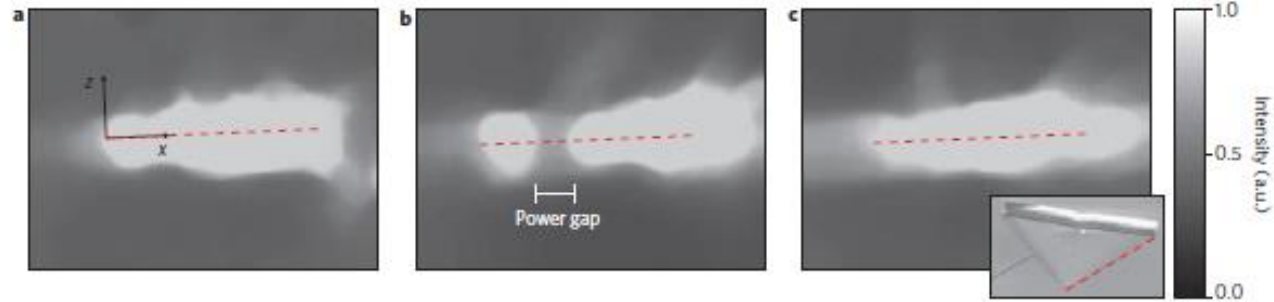
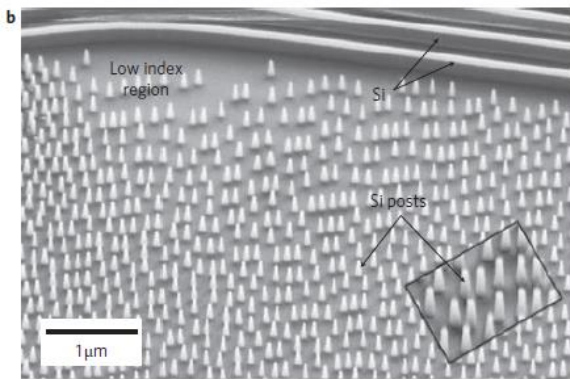
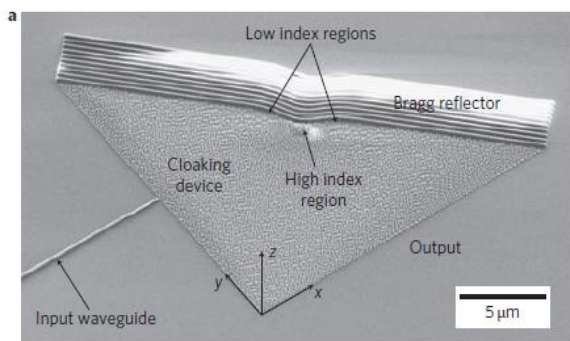

Ergin et. al. (2010)

Calcite Cloaking

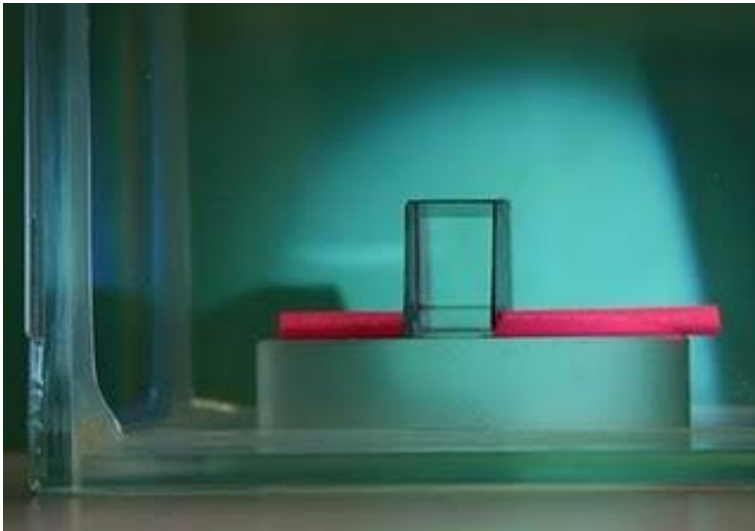
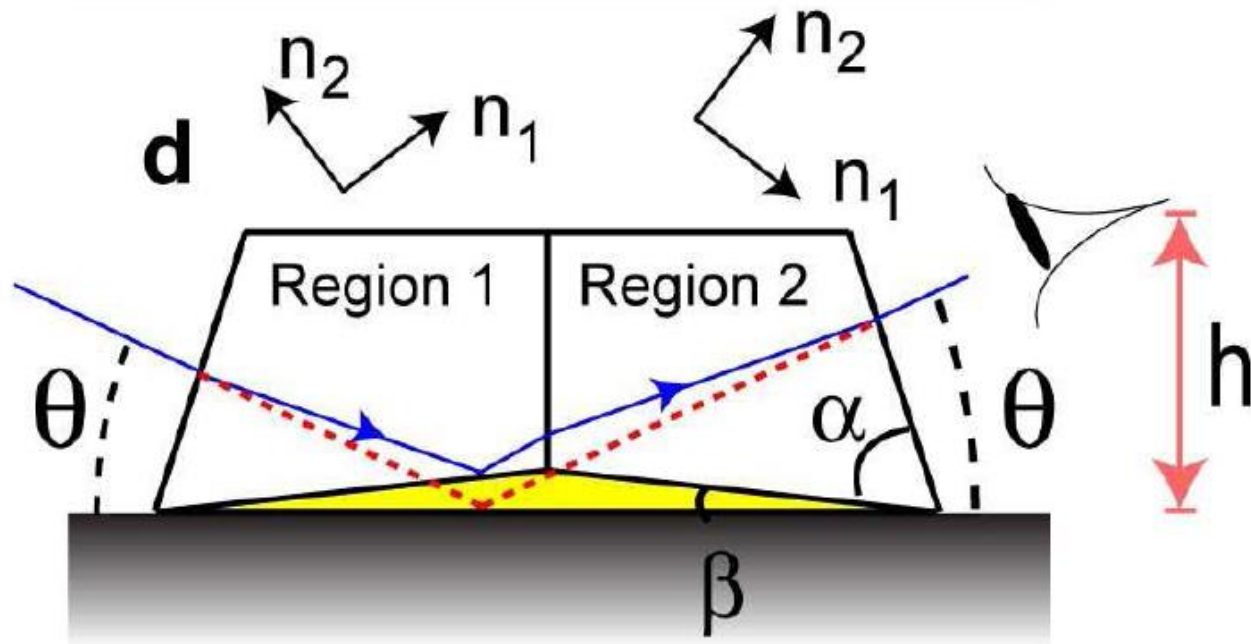

Zhang. et.al. (2011)

Chen et.al. (2011)

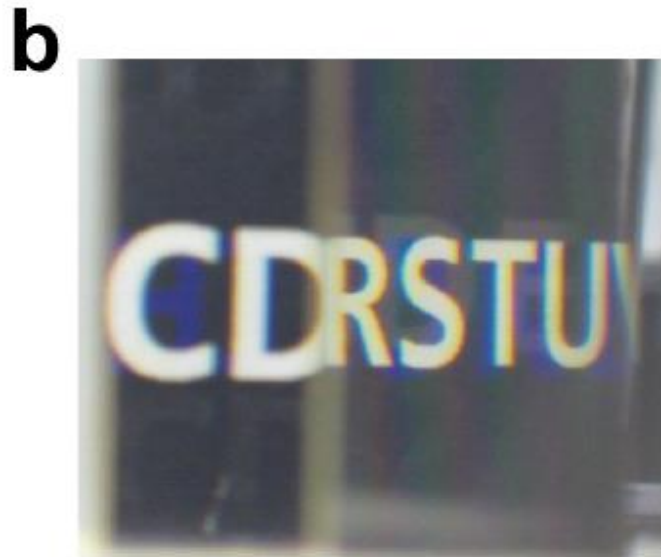
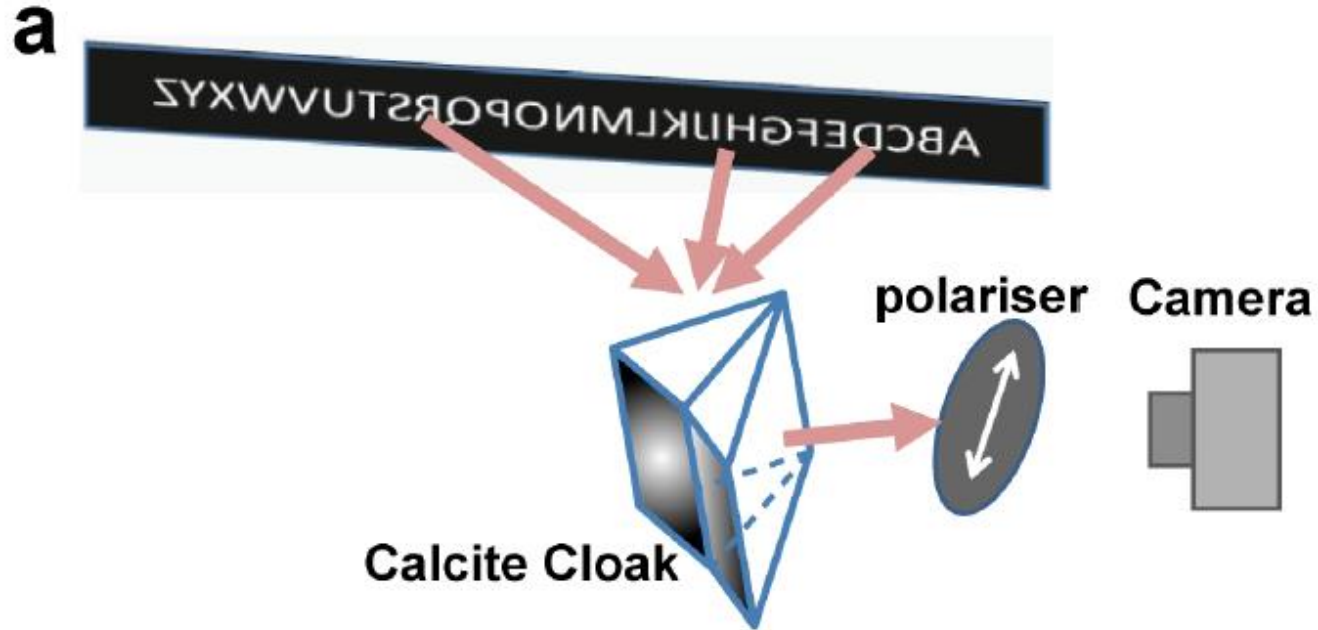

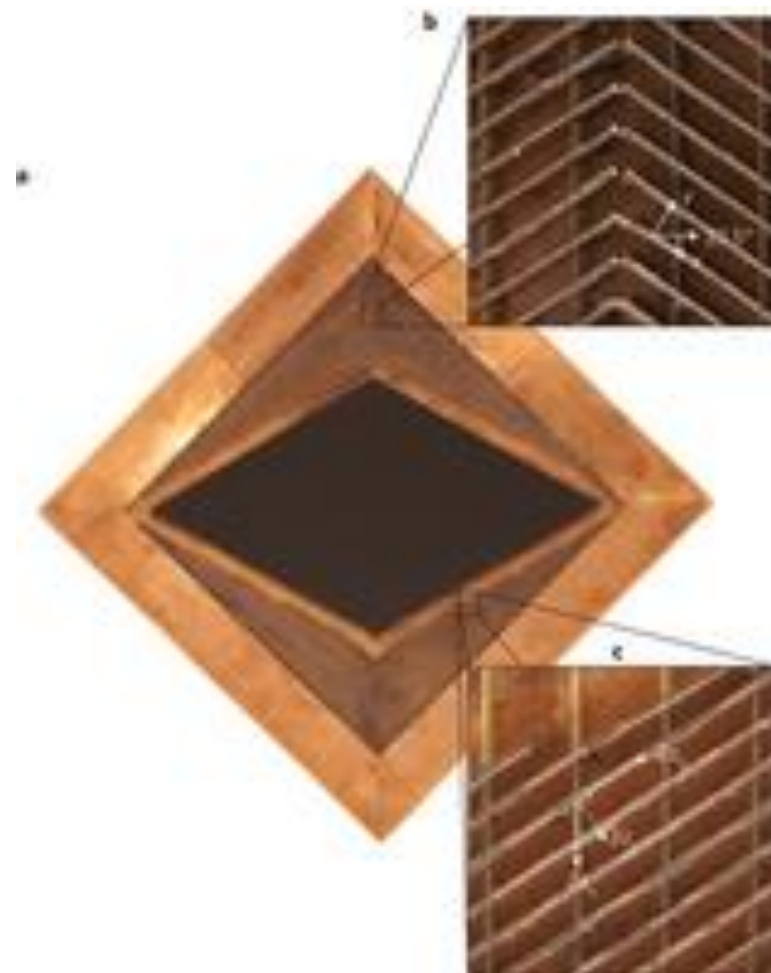
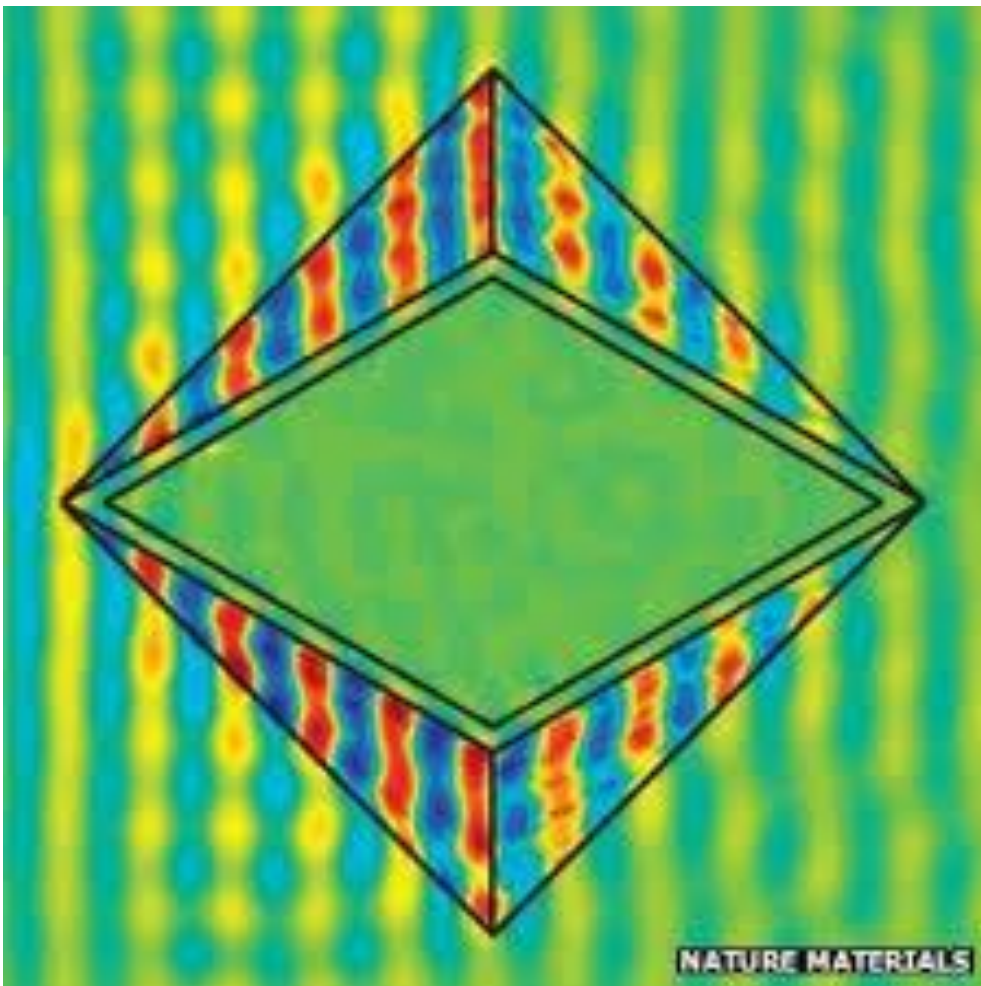

Unidirectional Cloak: Landy and Smith (2013)

Other transformation based
cloaking results

Non Euclidean cloaking: Leonhardt and Tyc (2008)

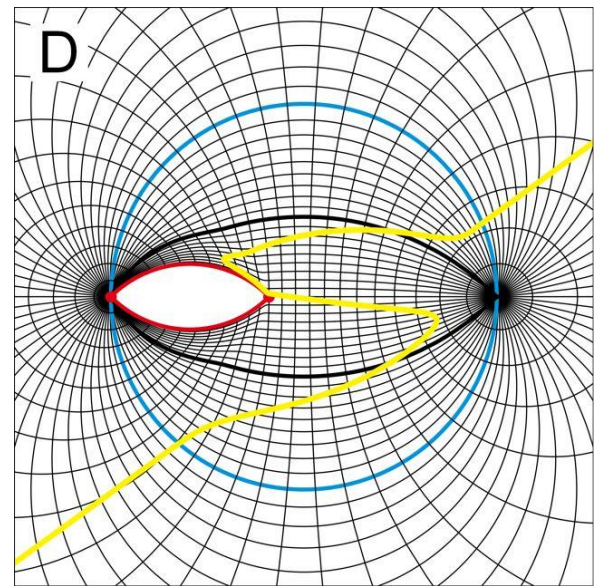
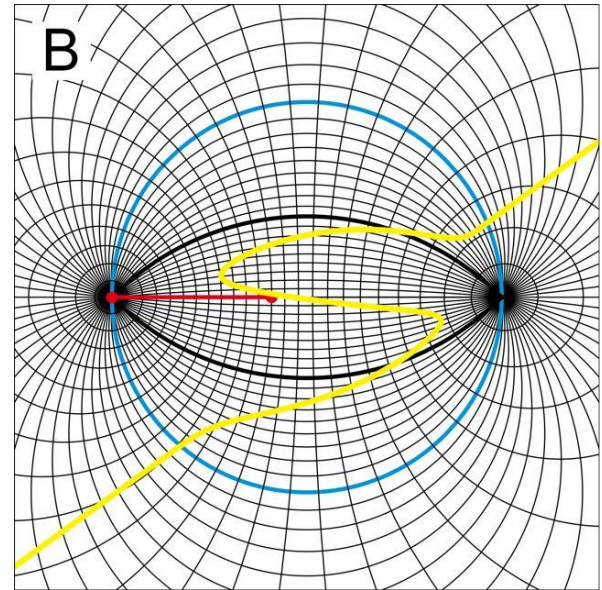
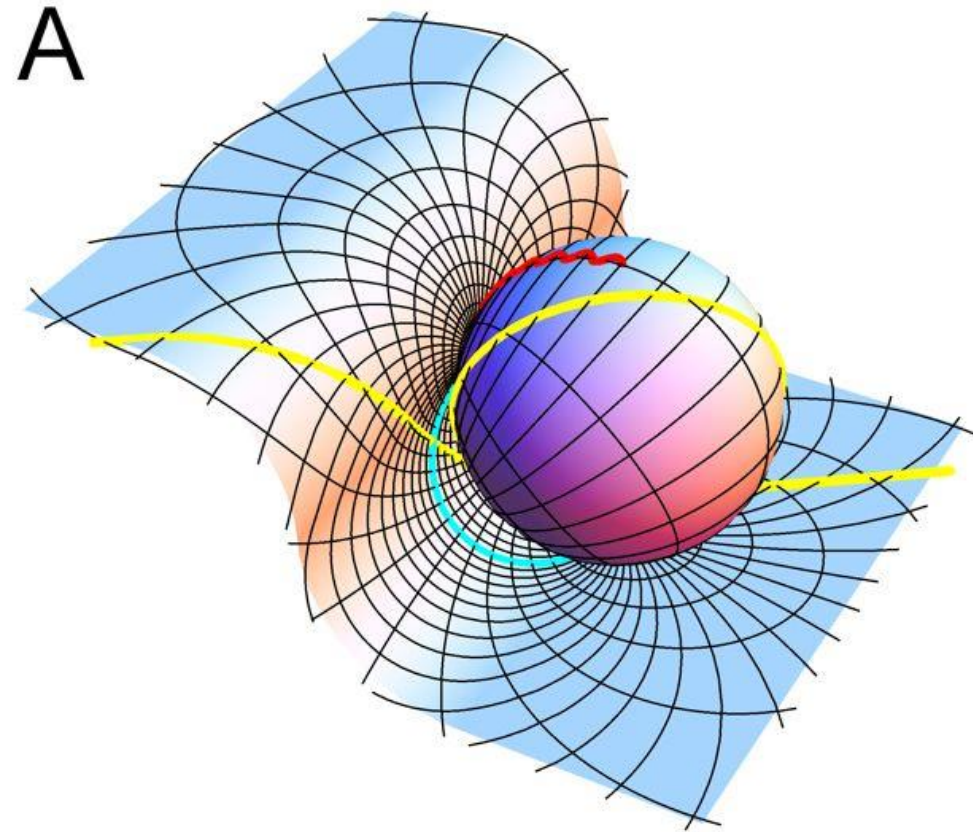

Optical Wormhole: Greenleaf et.al. 2007

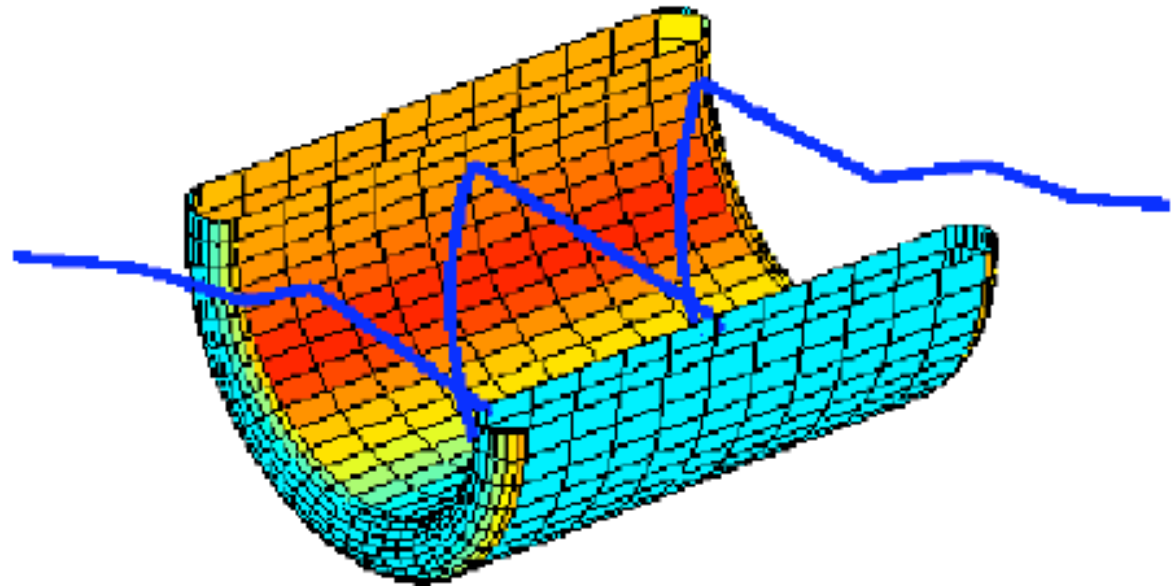
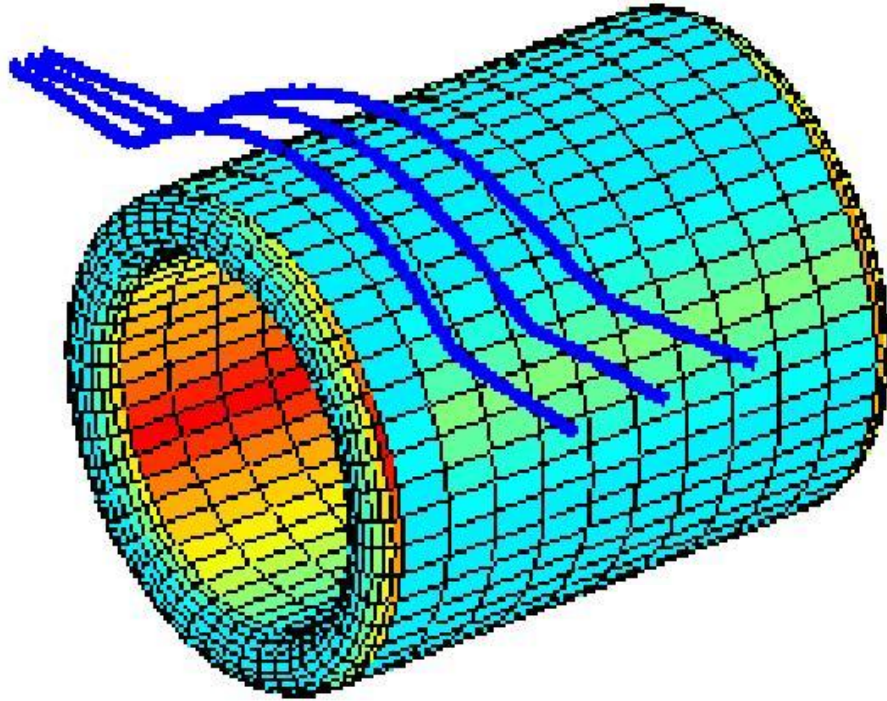

An important parallel:

Maxwell's Equations:

$$\frac{\partial}{\partial x_i} \left(C_{ijkl} \frac{\partial E_l}{\partial x_k} \right) = \{ \omega^2 \epsilon \mathbf{E} \}_j$$

$$C_{ijkl} = e_{ijm} e_{kln} \{ \boldsymbol{\mu}^{-1} \}_{mn}$$

Continuum Elastodynamics:

$$\frac{\partial}{\partial x_i} \left(C_{ijkl} \frac{\partial u_l}{\partial x_k} \right) = - \{ \omega^2 \rho \mathbf{u} \}_j$$

Cloaking for elasticity (with Marc Briane and John Willis, 2006)

Idea: Apply the Greenleaf, Lassas and Uhlmann/Pendry, Schurig, Smith method of cloaking to elastic waves

Requires new materials with new behavior, in particular, materials with anisotropic density

Cummer & Schurig (2007), Greenleaf et.al. (2007)
Chen & Chan (2007) found that materials with anisotropic density are also needed for cloaking against sound

A material with anisotropic effective density

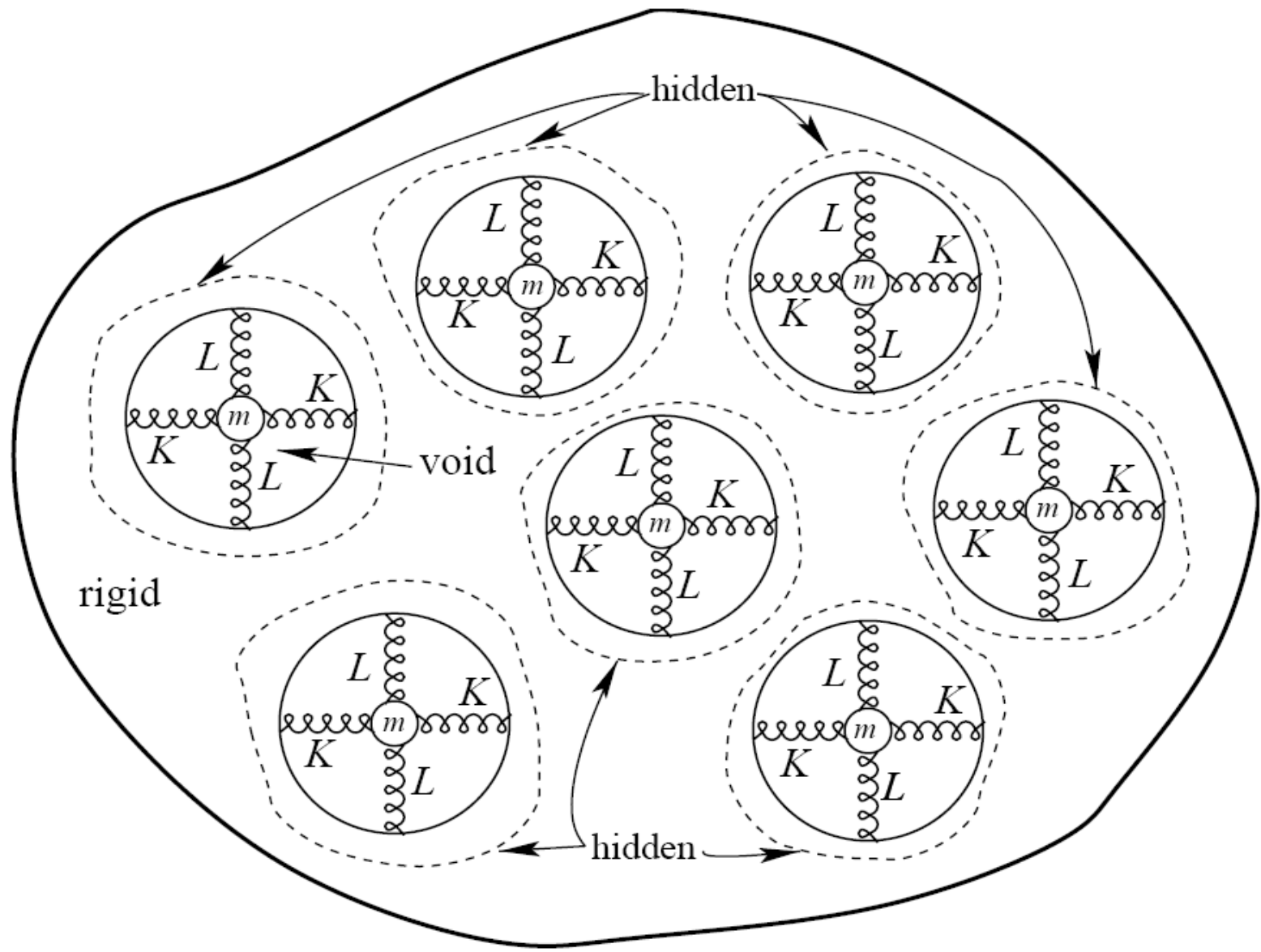

Transformation of the elastodynamic equations

$$\nabla \cdot \sigma = -\omega^2 \rho \mathbf{u}, \quad \sigma = \mathbf{C} \nabla \mathbf{u}$$

under the transformation $\mathbf{x} \rightarrow \mathbf{x}'(\mathbf{x}), \quad \mathbf{u} \rightarrow \mathbf{u}'(\mathbf{x}')$

with $\mathbf{u}'(\mathbf{x}') = (\mathbf{A}^T)^{-1} \mathbf{u}(\mathbf{x}), \quad A_{ij} = \frac{\partial x'_i}{\partial x_j}$

transform to

$$\nabla \cdot \sigma' = \mathbf{D}' \nabla \mathbf{u}' - \omega^2 \rho' \mathbf{u}', \quad \sigma = \mathbf{C}' \nabla \mathbf{u}' + \mathbf{S}' \mathbf{u}'$$

where

$$\rho'_{pq} \approx \frac{\rho}{a} \frac{\partial x'_p}{\partial x_i} \frac{\partial x'_q}{\partial x_i} + \frac{1}{\omega^2 a} \frac{\partial^2 x'_p}{\partial x_i \partial x_j} C_{ijkl} \frac{\partial^2 x'_q}{\partial x_k \partial x_\ell}$$

$$C'_{pqrs} \approx \frac{1}{a} \frac{\partial x'_p}{\partial x_i} \frac{\partial x'_q}{\partial x_j} C_{ijkl} \frac{\partial x'_r}{\partial x_k} \frac{\partial x'_s}{\partial x_\ell}$$

$$S'_{pqr} = \frac{1}{a} \frac{\partial x'_p}{\partial x_i} \frac{\partial x'_q}{\partial x_j} C_{ijkl} \frac{\partial^2 x'_r}{\partial x_k \partial x_\ell} = S'_{pqr}$$

$$D'_{pqr} = S'_{qrp} \quad a = \det \mathbf{A}$$

These equations don't look like elastodynamic equations at all! But they are a special case of the Willis equations

$$\begin{pmatrix} \langle \sigma \rangle \\ \langle \mathbf{p} \rangle \end{pmatrix} = \begin{pmatrix} \mathbf{C}^{\text{eff}} & \mathbf{S}^{\text{eff}} \\ (\mathbf{S}^{\text{eff}})^{\dagger} & \rho^{\text{eff}} \end{pmatrix} * \begin{pmatrix} \langle \epsilon \rangle \\ \langle \dot{\mathbf{u}} \rangle \end{pmatrix}$$

$$\nabla \cdot \langle \sigma \rangle = \langle \dot{\mathbf{p}} \rangle, \quad \langle \epsilon \rangle = [\nabla \langle \mathbf{u} \rangle + (\nabla \langle \mathbf{u} \rangle)^T] / 2$$

Brackets $\langle \rangle$ denote ensemble averages

* denotes a convolution with respect to time

$\mathbf{C}^{\text{eff}}, \mathbf{S}^{\text{eff}}, \rho^{\text{eff}}$ are operators which are generally non-local in space

However unlike the Willis equations, one wants the constitutive law to be local in space and to apply (macroscopically) to a single realization of a microstructure rather than the ensemble average.

Are there composites where such a constitutive law is realized?

Note: Brun, Guenneau and Movchan (2009) have shown that one can obtain cloaks with $S=D=0$ with C not satisfying the usual symmetries, by letting $\mathbf{u}'(\mathbf{x}') = \mathbf{u}(\mathbf{x})$

Sheng, Zhang, Liu, and Chan (2003) found that materials could exhibit a negative effective density over a range of frequencies

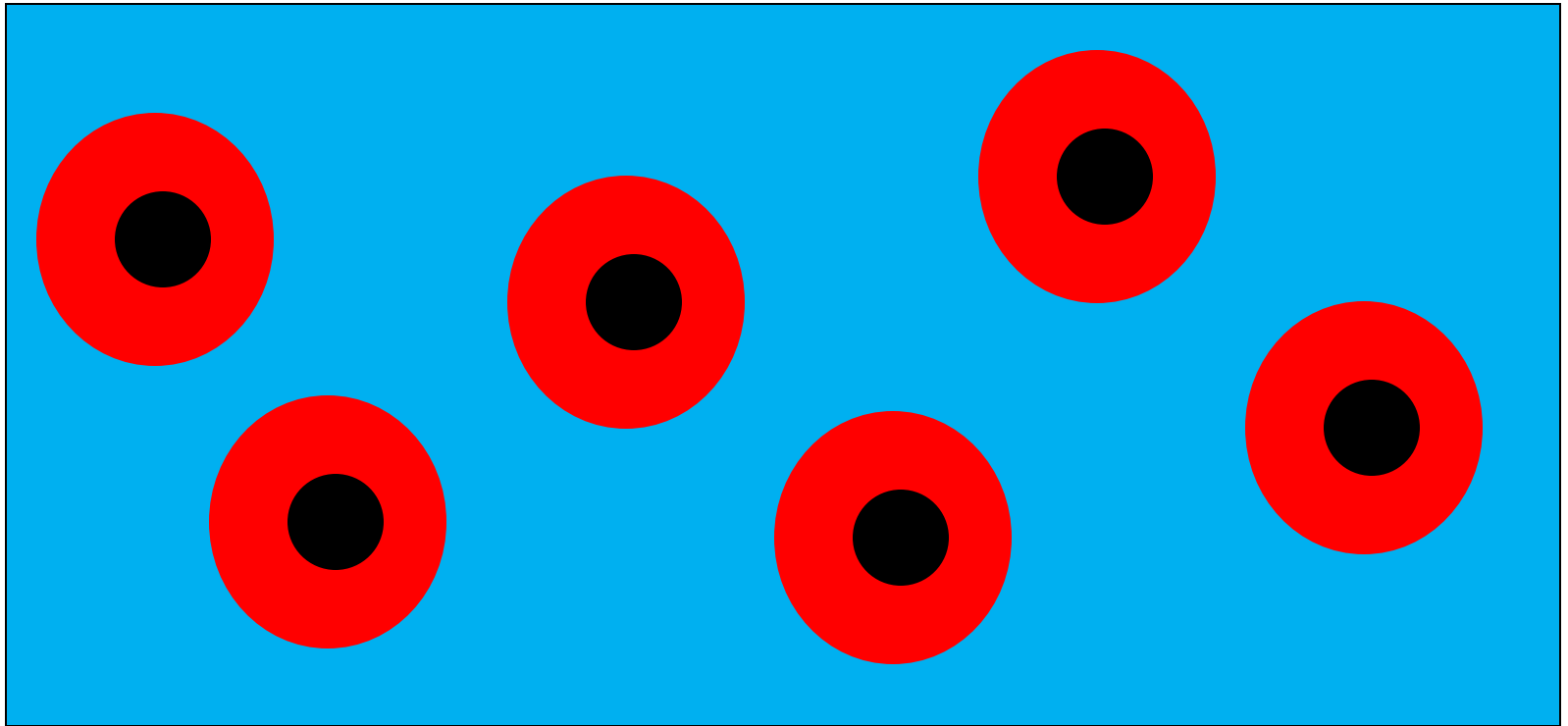

Red=Rubber, Black=Lead, Blue=Stiff Matrix

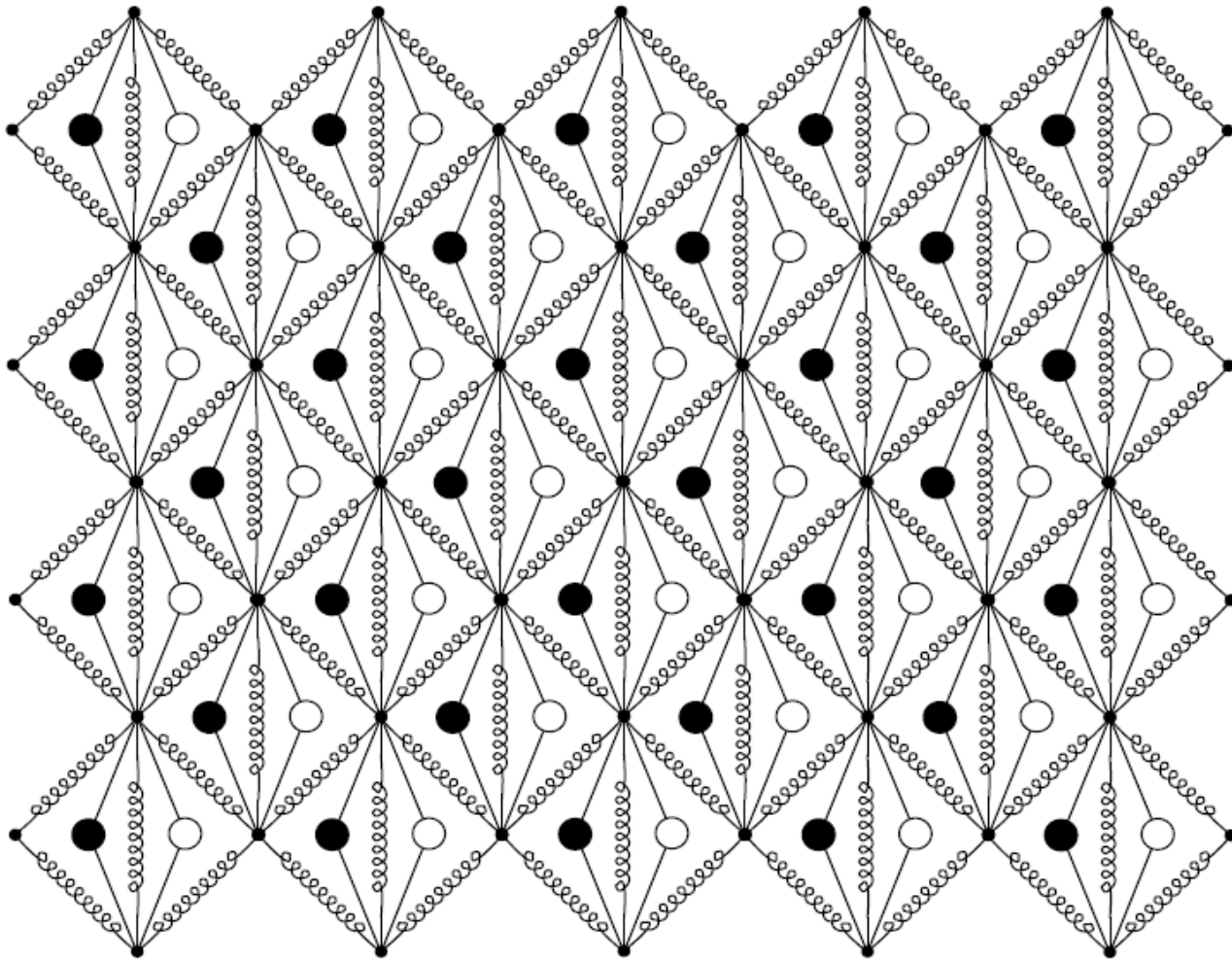

The Black circles have positive effective mass
The White circles have negative effective mass

Another idea for cloaking of elastic waves in plates was suggested by Farhat et.al. (2009) and experimentally realized by Stenger et.al. (2012)

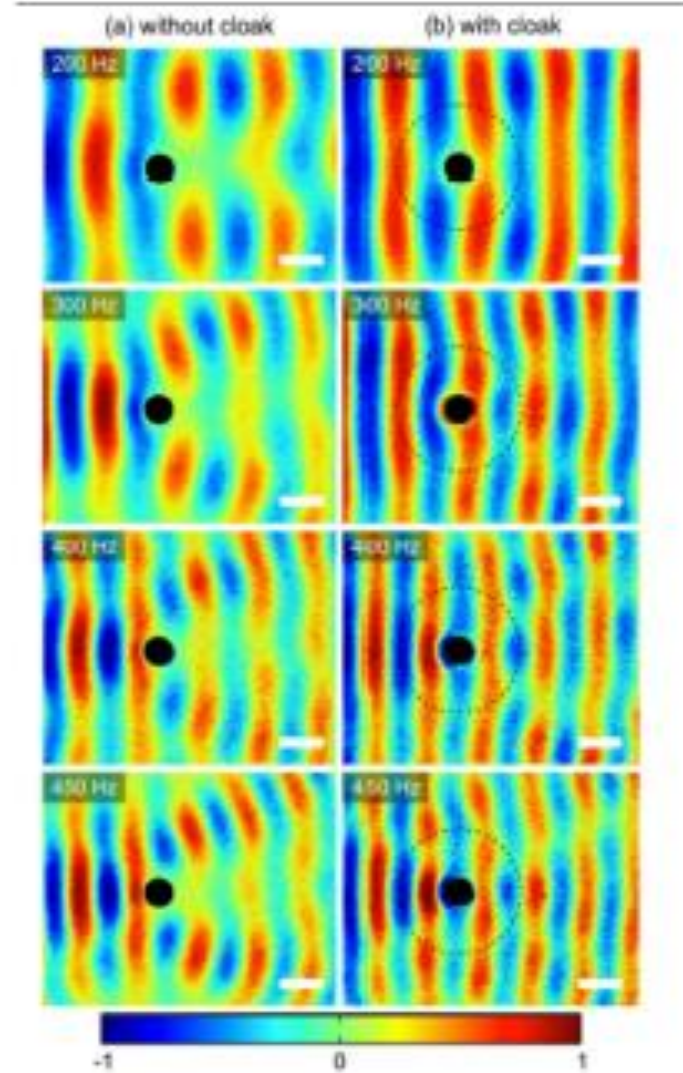
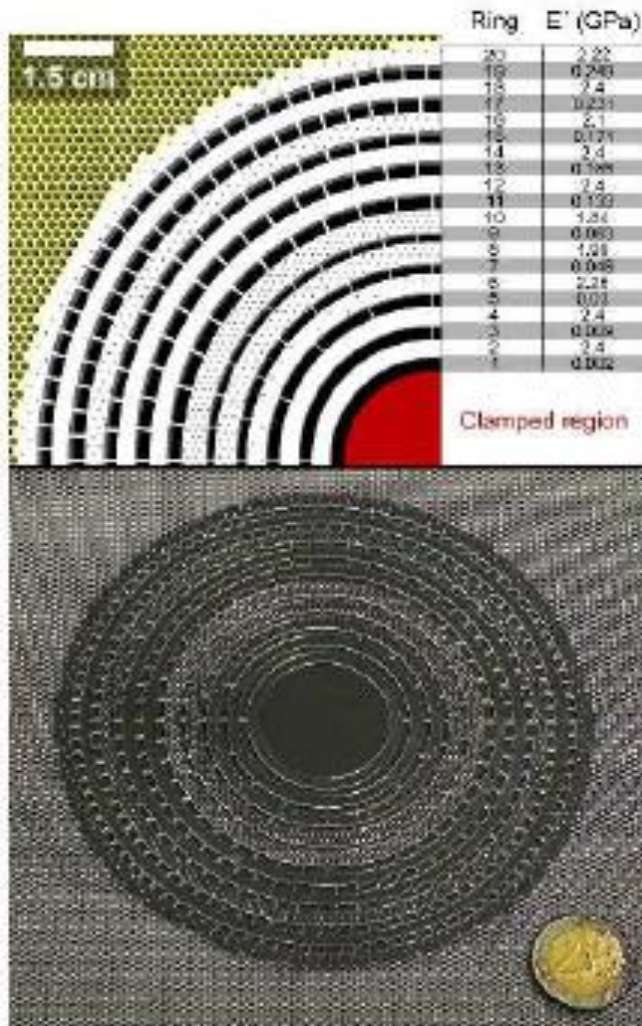

Cloaking on a grand scale: seismic cloaking

Brule et.al. (2014)

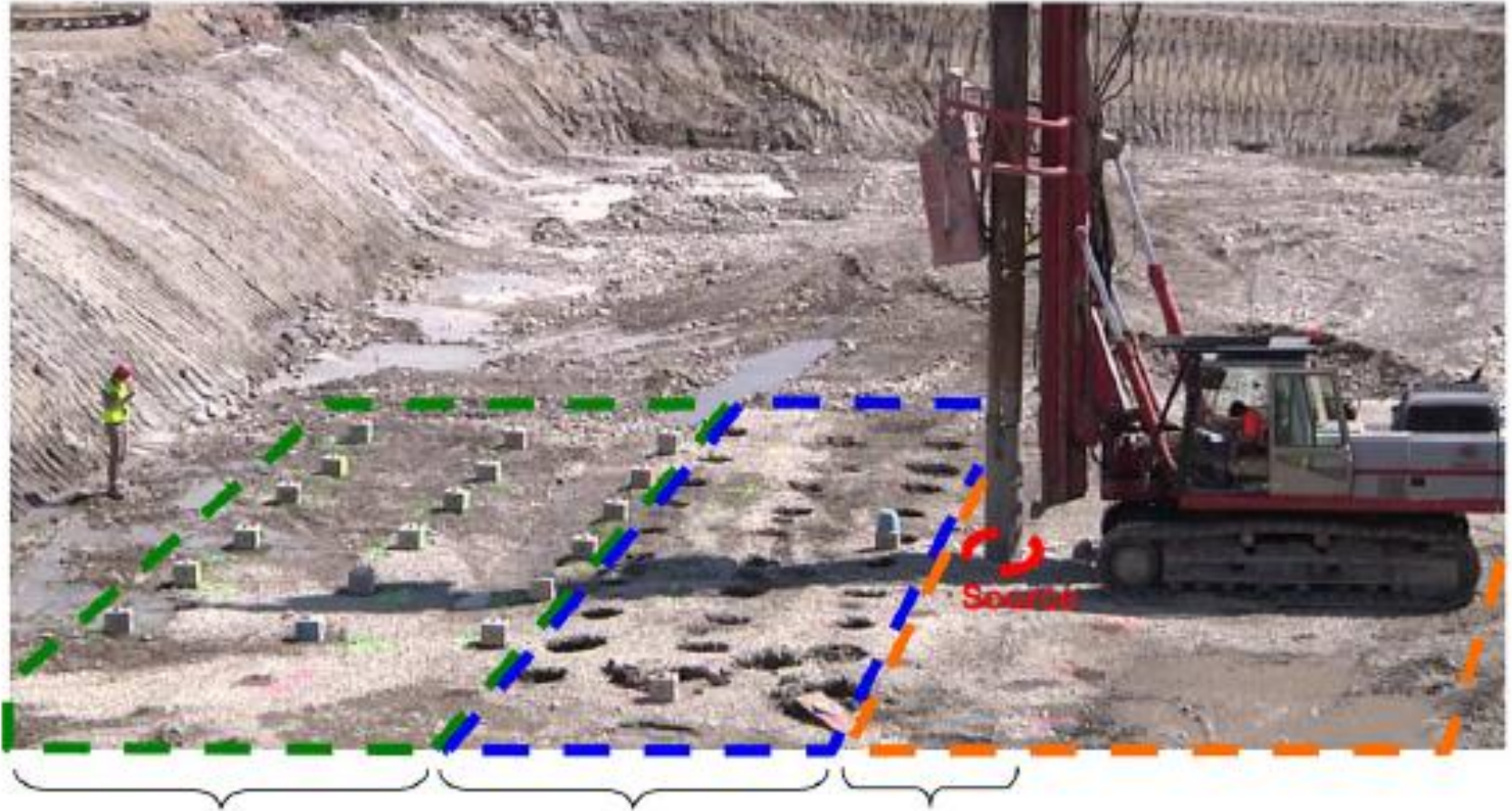

Sensitive three components
velocimeters (green grid)

Five meters deep
320 mm holes

Source :
- Frequency : 50 Hz
- Horizontal displacement : 14 mm

Exterior Cloaking.

Cloaking at a distance!

Besides transformation based cloaking there is also cloaking due to anomalous resonance which we discovered in 2005, prior to the work of Pendry, Schurig and Smith and Leonhardt on transformation based cloaking.

In contrast to transformation based cloaking the cloaking region lies **outside the cloaking device.**

$$\nabla \cdot \epsilon \nabla V = 0$$

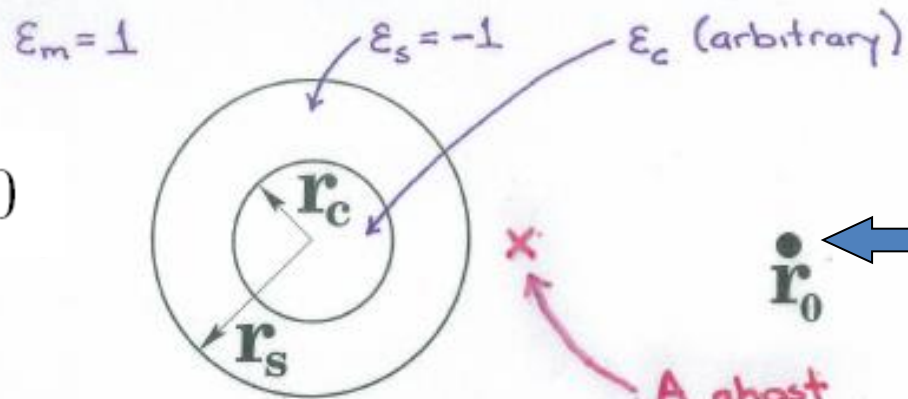

Source

Is equivalent to

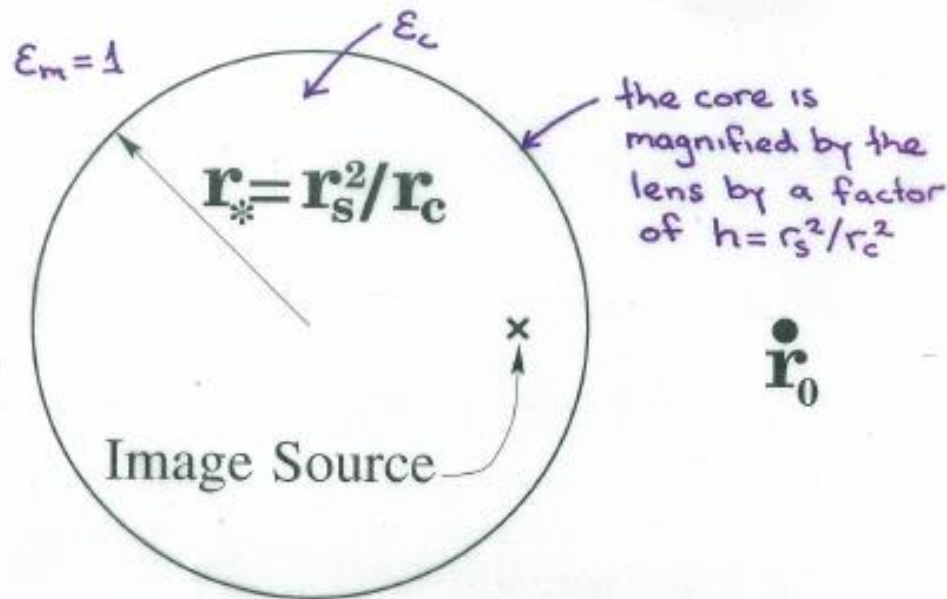

How and in what sense can the equivalence hold?

$$\epsilon_m = 1$$

Optical and dielectric properties of partially resonant composites

N. A. Nicorovici and R. C. McPhedran

Department of Theoretical Physics, School of Physics, University of Sydney, Sydney, New South Wales 2006, Australia

G. W. Milton*

Department of Mathematics, University of Utah, Salt Lake City, Utah 84112

(Received 2 November 1993)

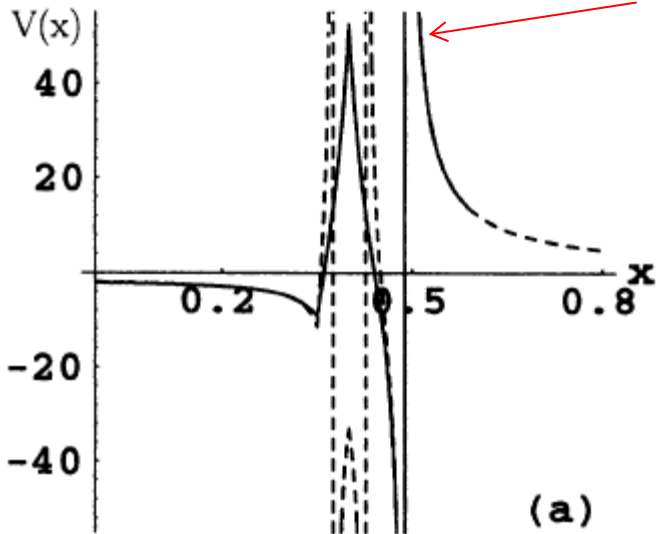
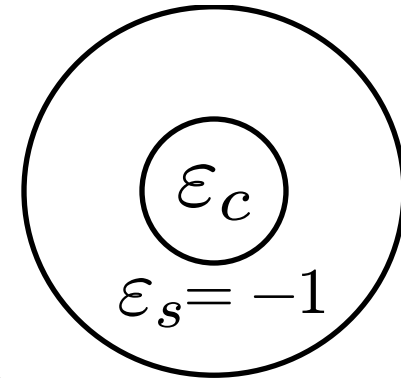

First Discovery of a Ghost Source

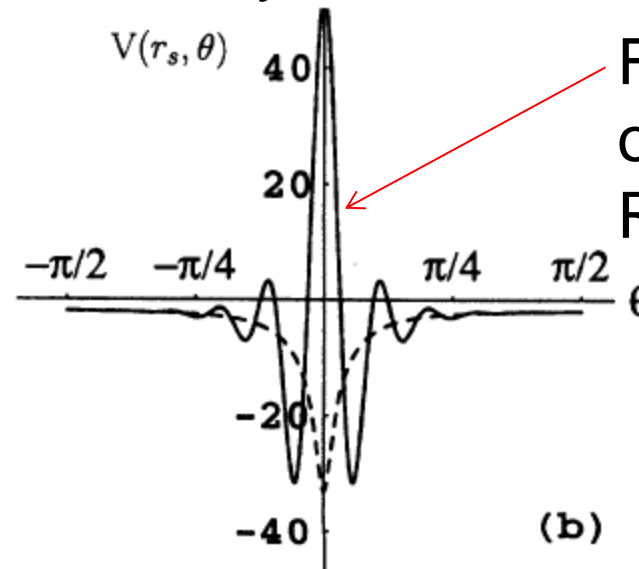

First Discovery of Anomalous Resonance

(Shell radius=0.4, Core radius=0.35)

Ghost sources and anomalous resonance are the essential mechanisms that explain superlensing.

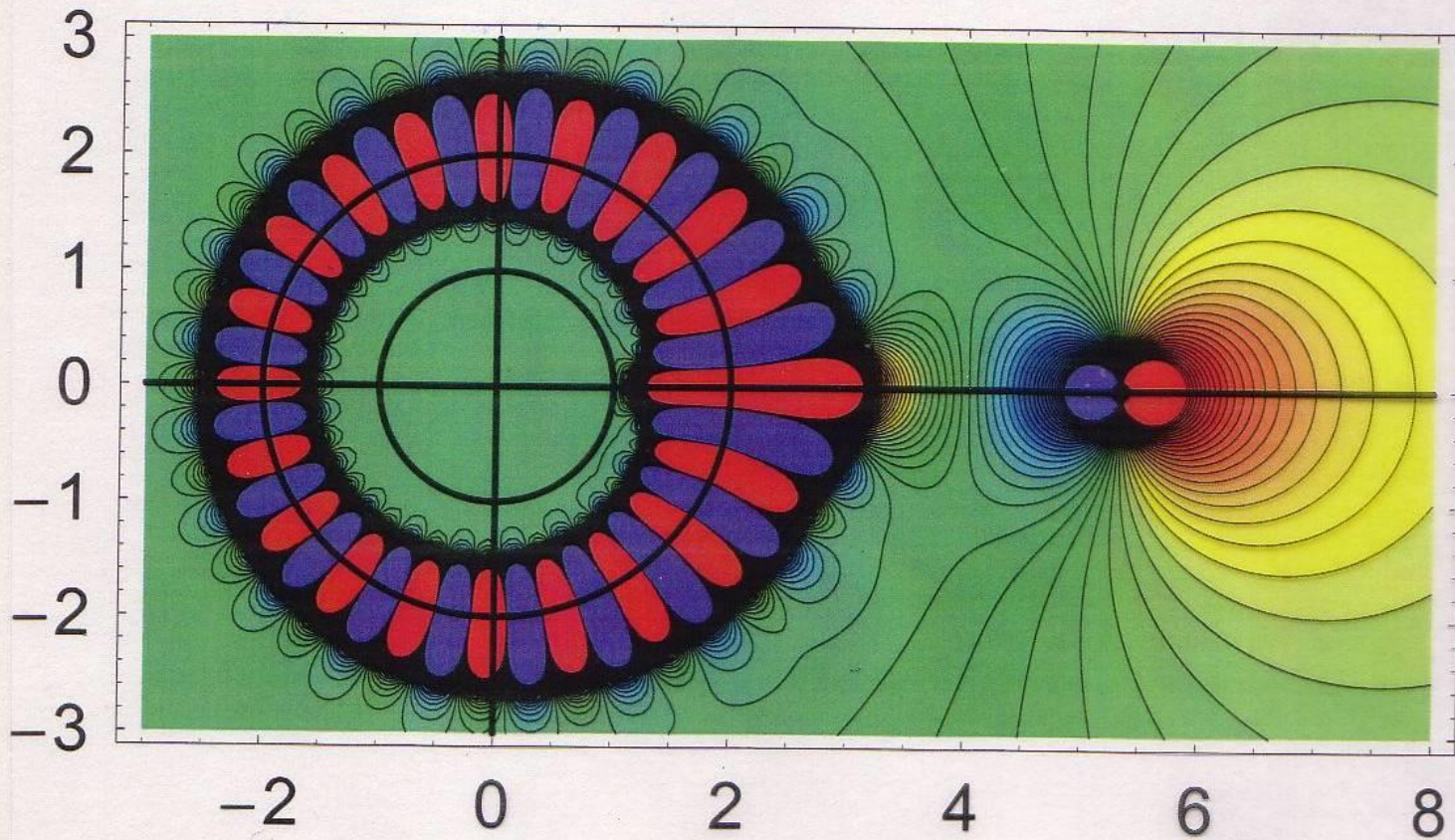

Real V

$$\epsilon_c = 100$$

$$\epsilon_s = -1 + 10^{-12}i$$

$$\epsilon_m = 1$$

Later
Simulation

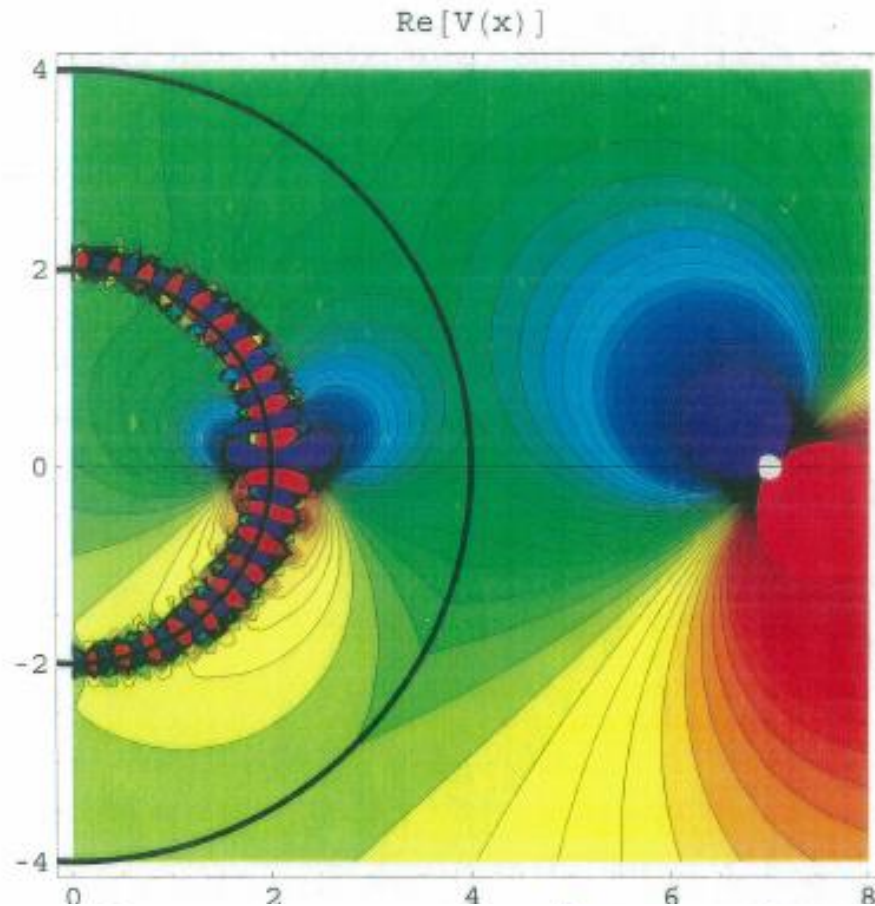

When the shell was hollow we found it was completely invisible to any applied field

Very similar phenomena were later found to be associated with the Veselago lens by Pendry (2000) and subsequent workers. Their work again indicated apparent point image sources in the physical region and large fields on one side of them.

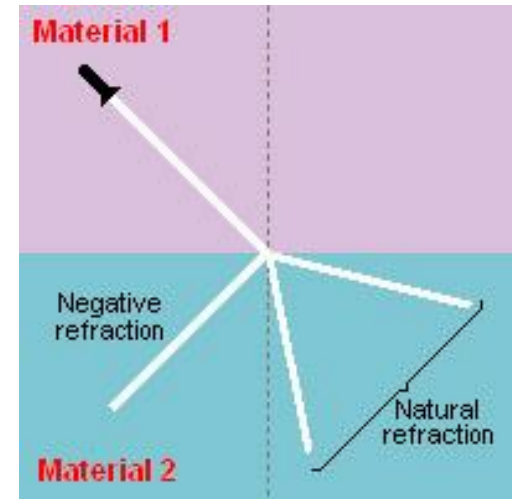
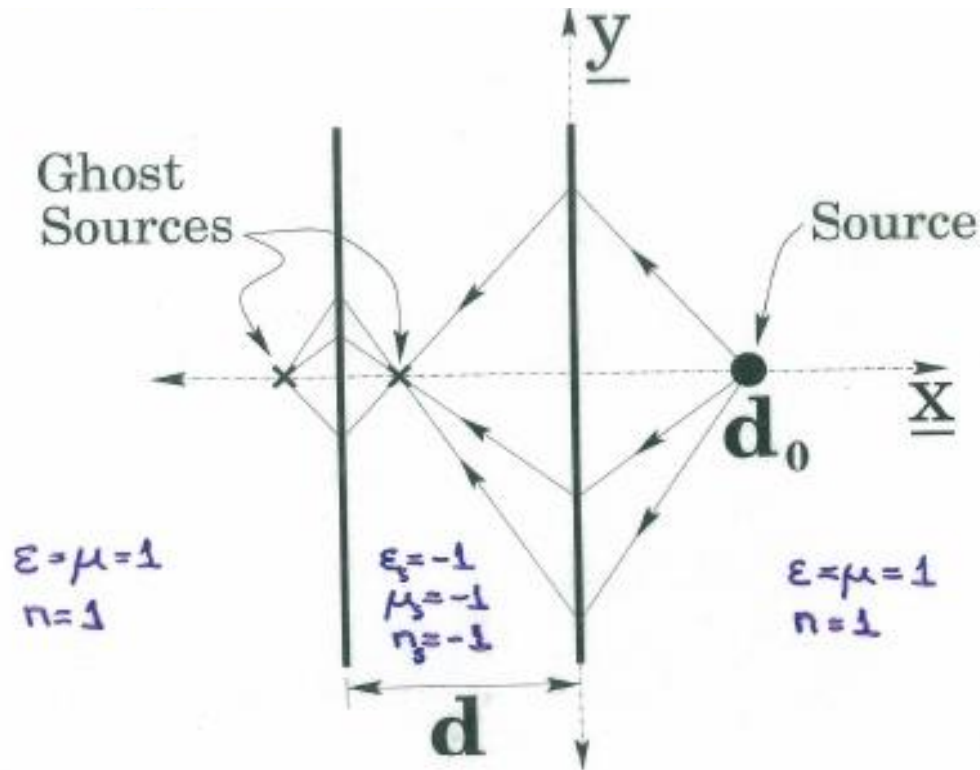

Wrong Picture

Negative Refraction Simulation: Hess 2008

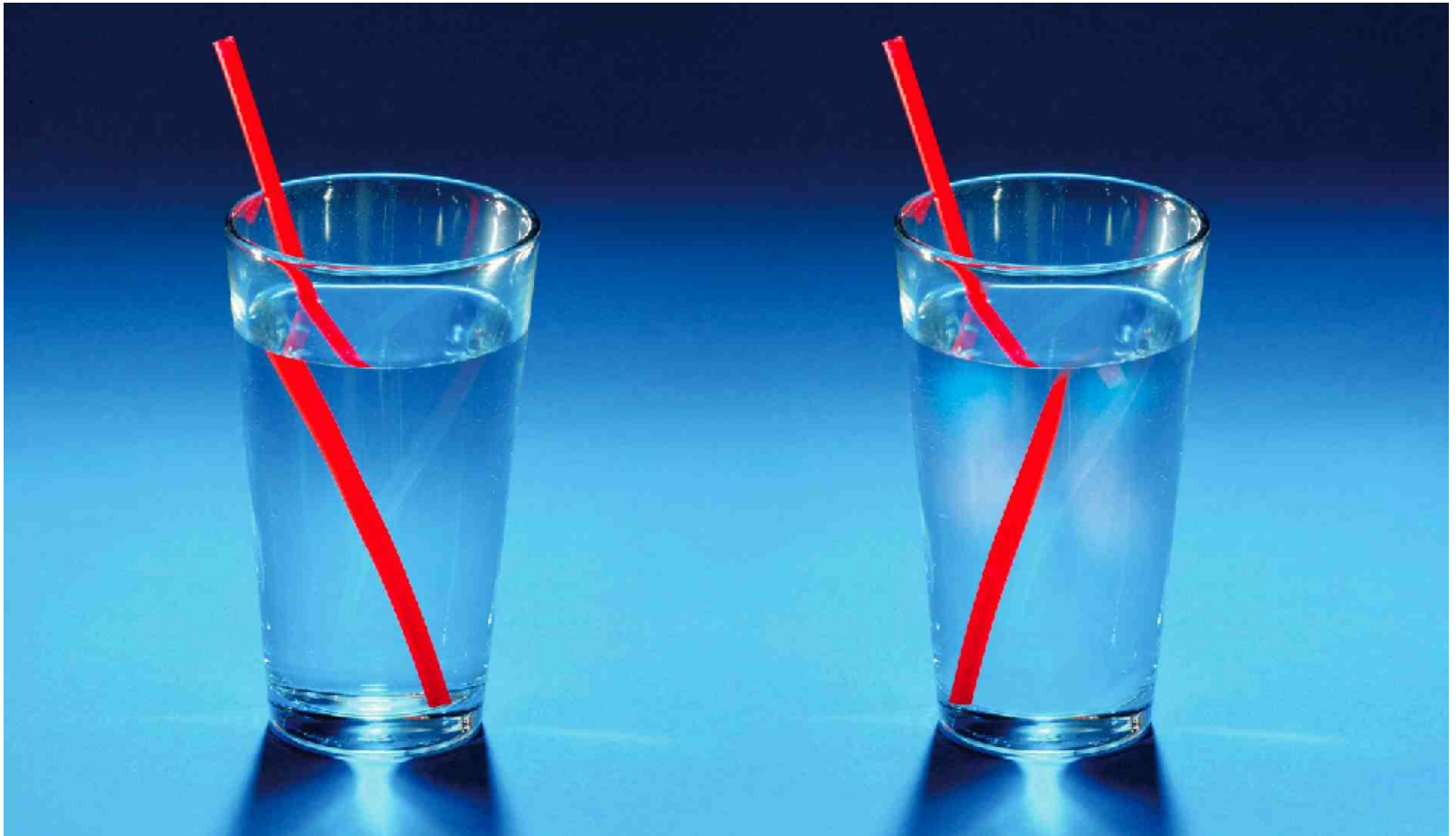

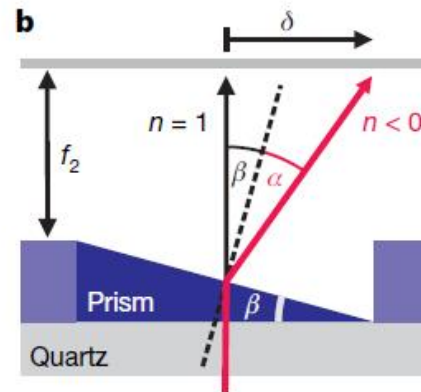
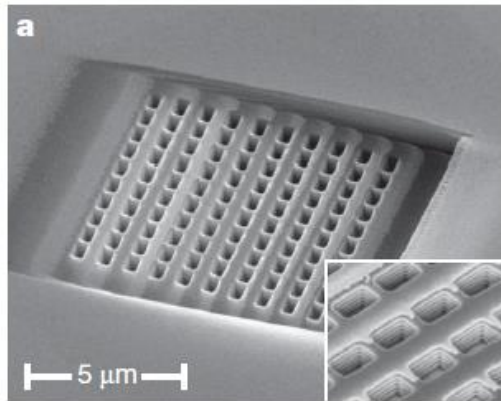
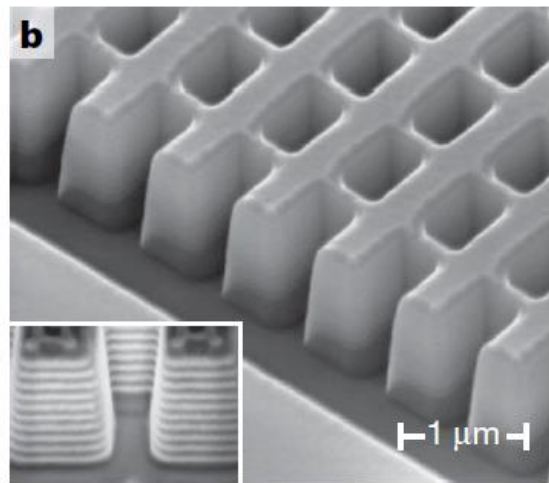
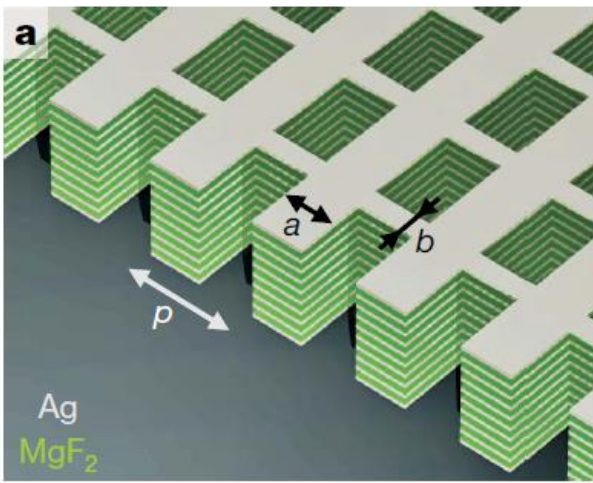

Negative refraction at optical frequencies:
Valentine et. al.(2008)

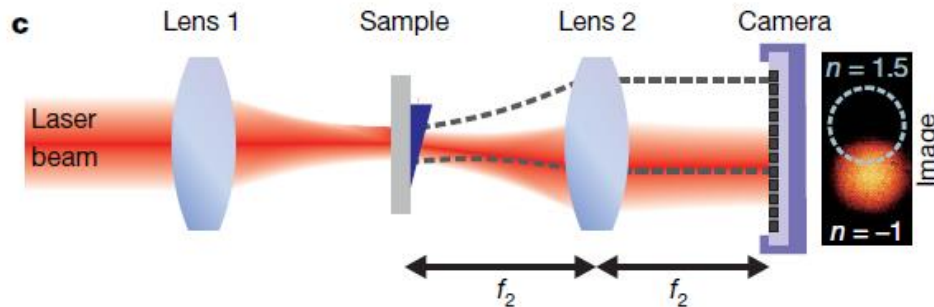

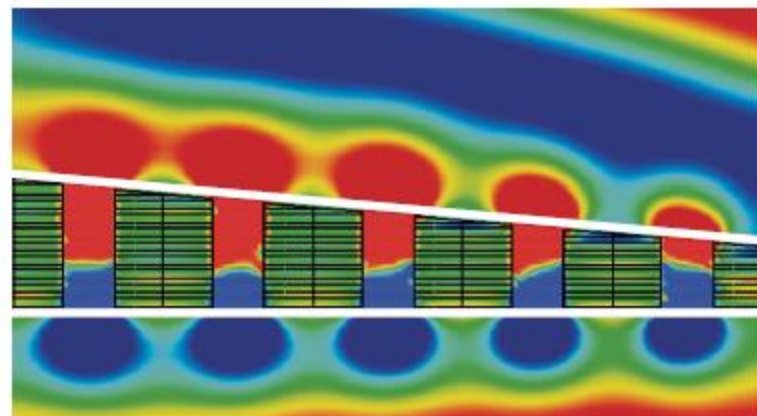
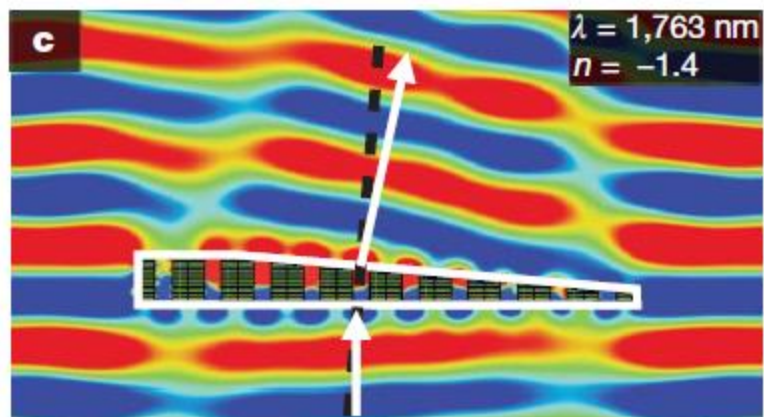
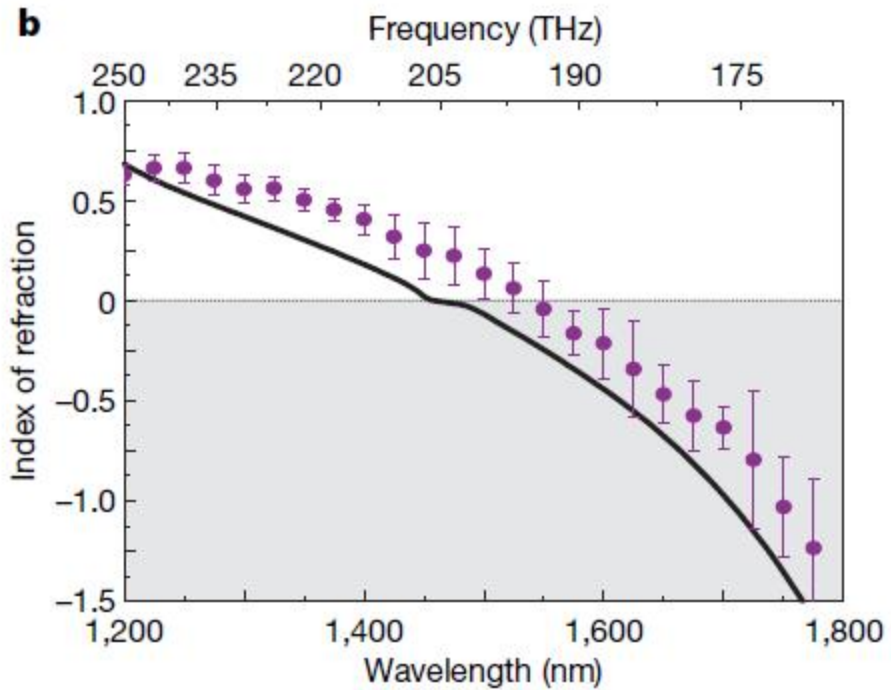
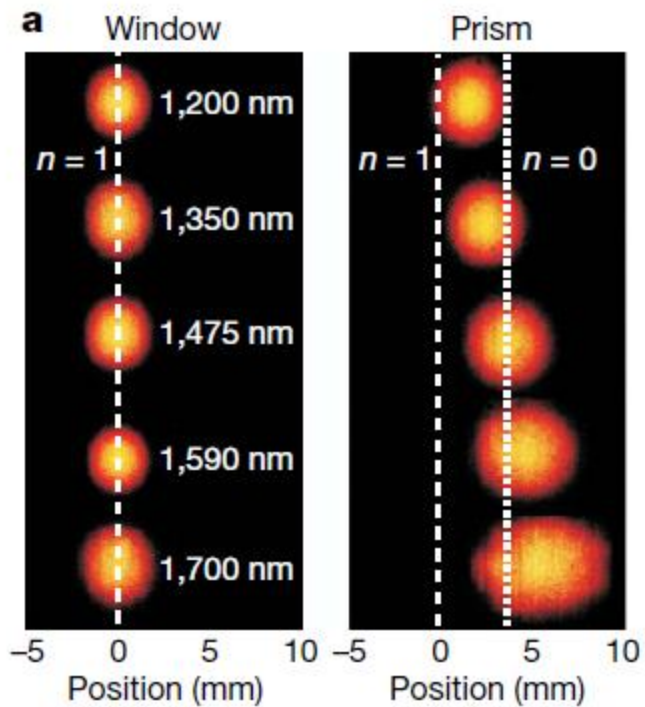

The superlens: Pendry (2000)

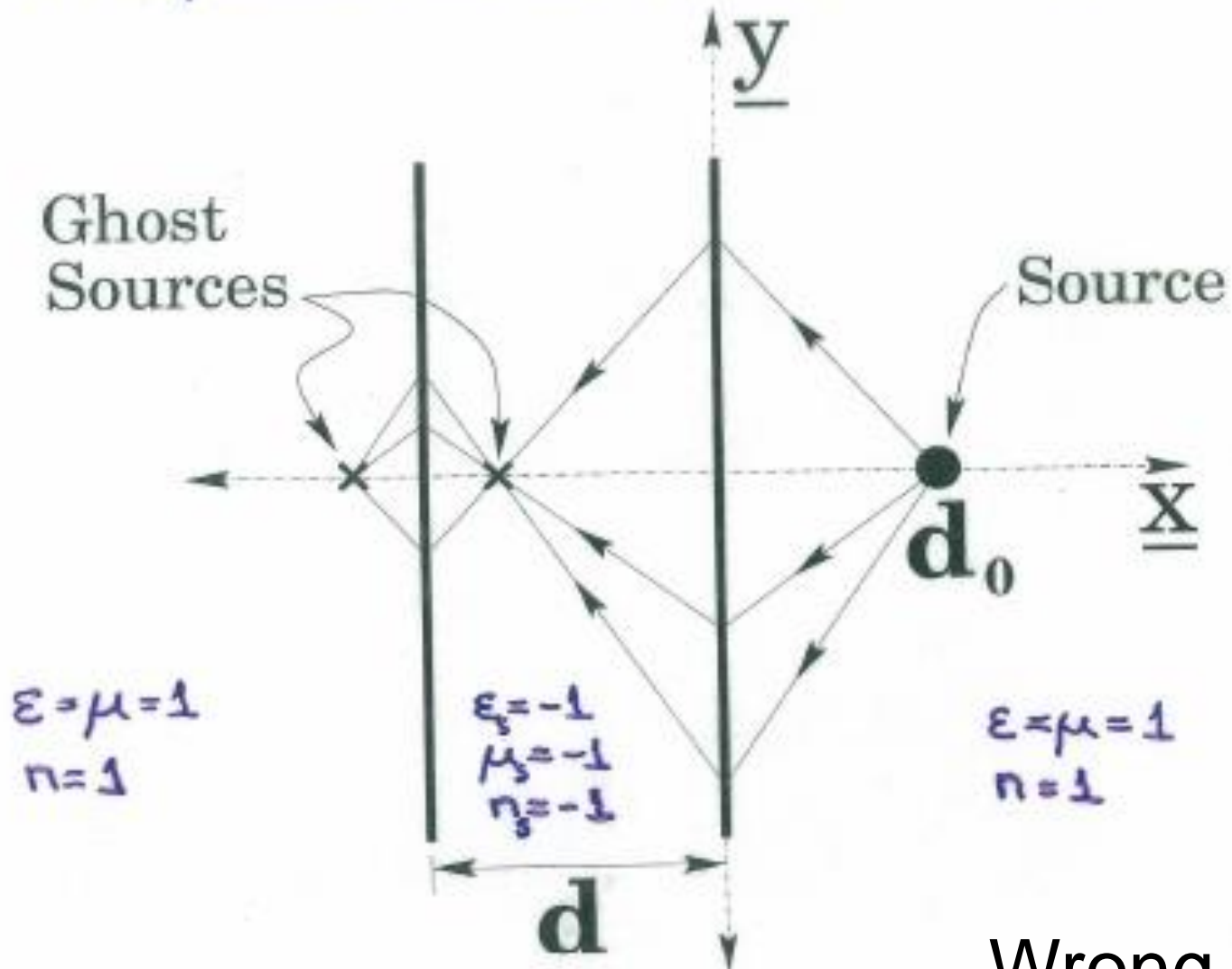

Wrong Picture

Veselago Lens (1967)

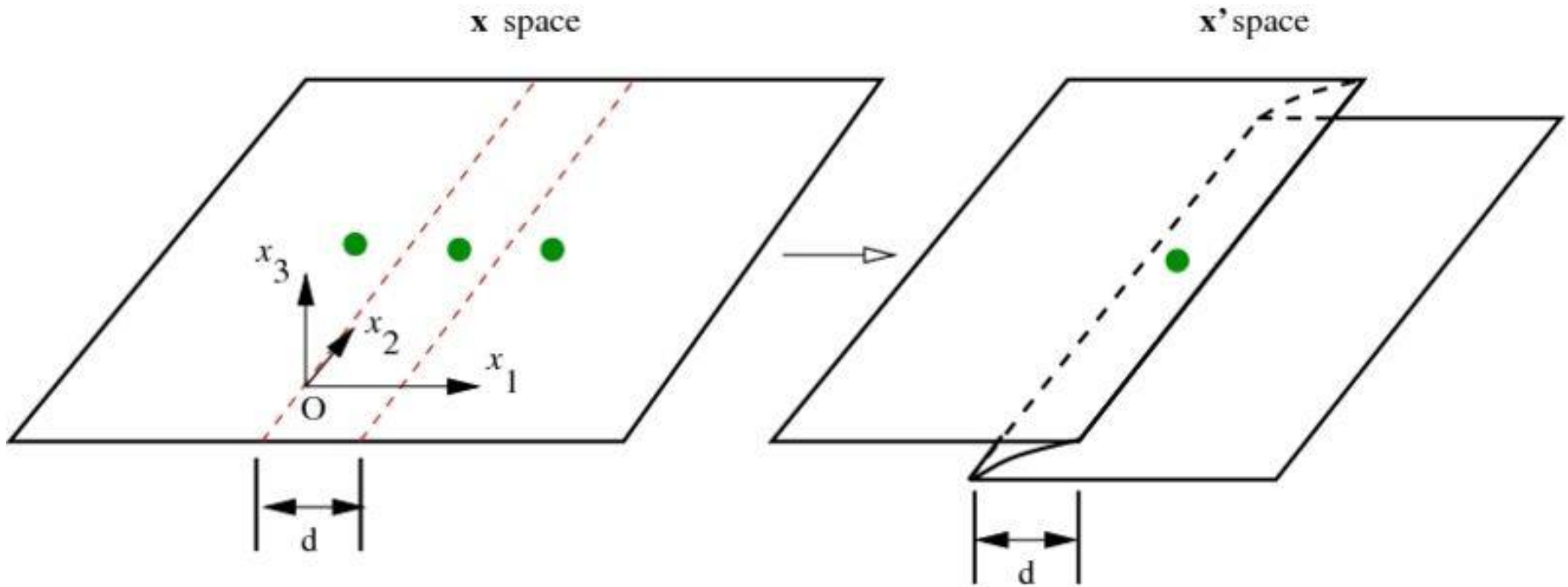

Folding space: Leonhardt and Philbin (2006)

Wrong Picture

Work by Garcia and Nieto-Vesperinas (2002) and Pokrovsky and Efros (2002) indicated large fields between the ghost sources.

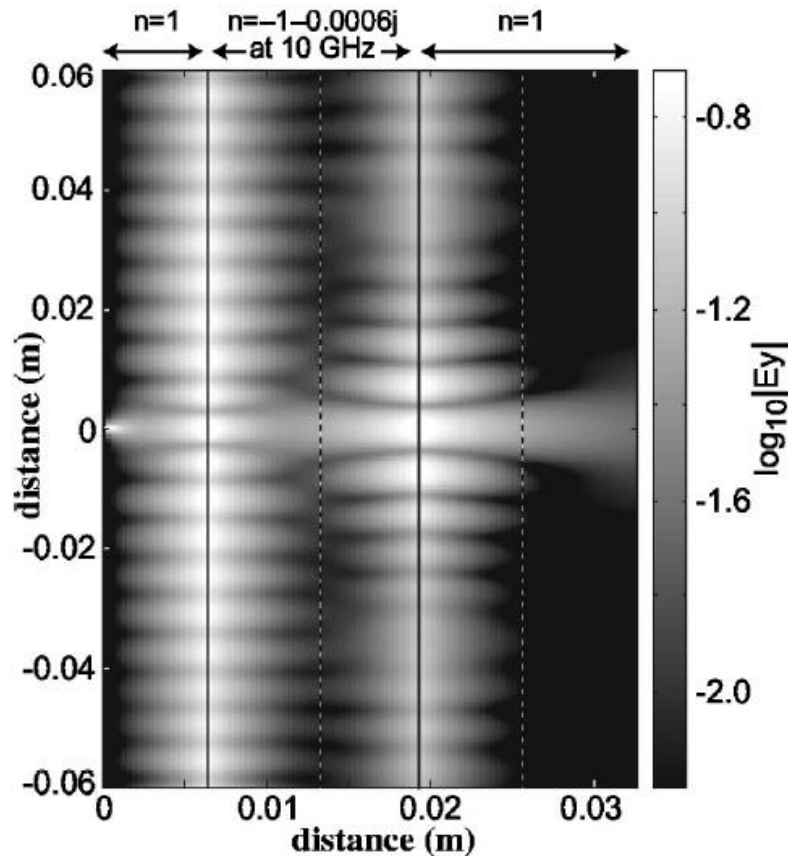

Correct
Picture

Numerical Results of Cummer (2003) showing the anomalously resonant regions on both sides of the lens

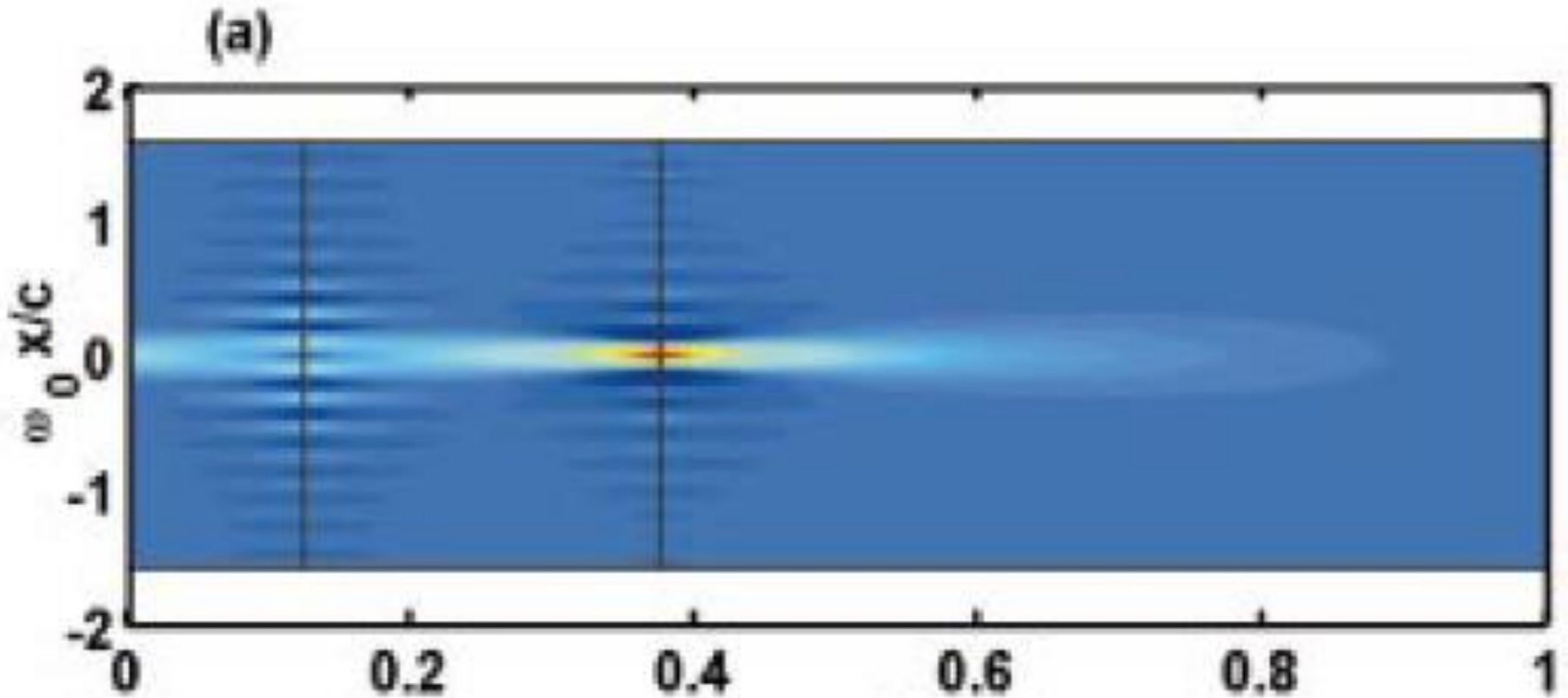

Numerical results of Shvets (2003) indicating the anomalously resonant regions centered at both the front and back sides of the lens

Finite power absorbed

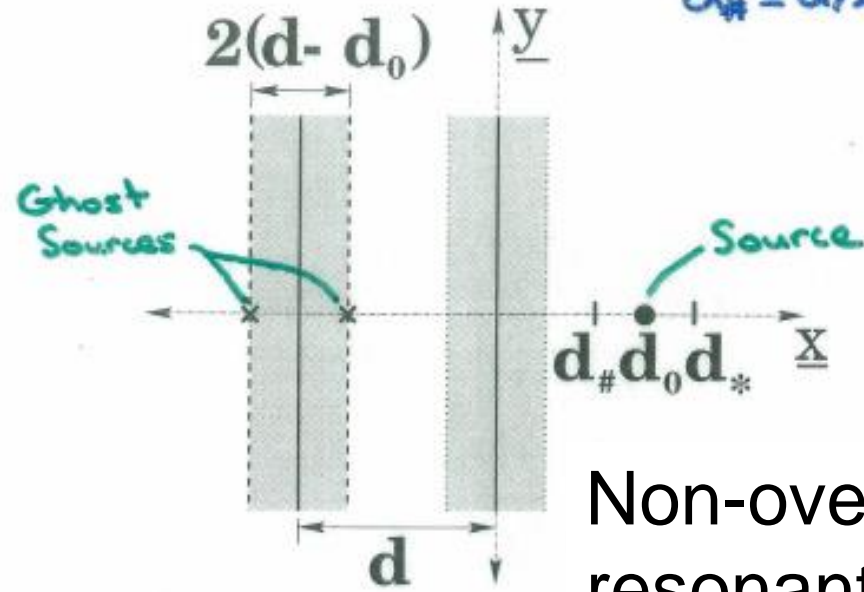

Non-overlapping resonant regions

Infinite power absorbed!!

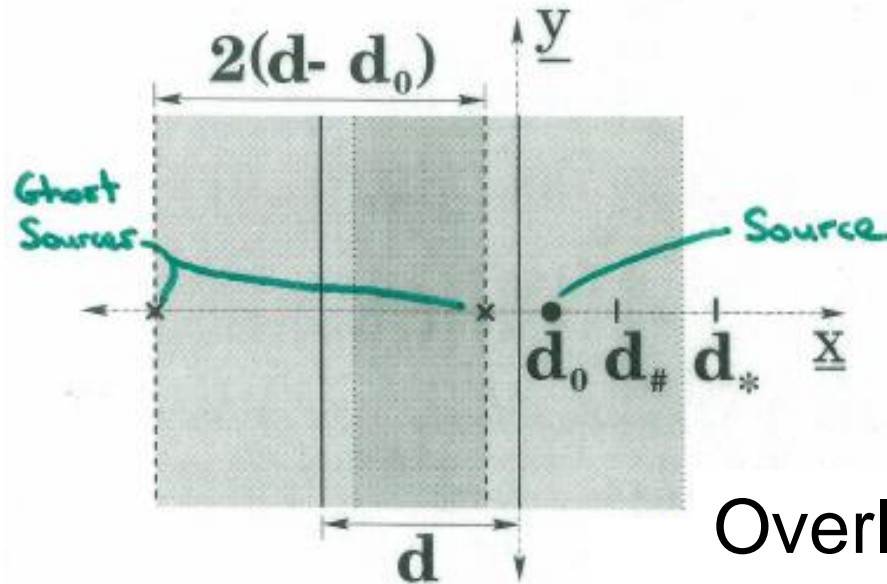

Overlapping resonant regions

KEY POINT:

When the source is closer than a distance $d/2$ from the lens it interacts with the enormously large anomalously resonant fields in front of the lens.

These fields act like a sort of “optical molasses” against which the point source has to do work per unit time, in fact an infinite amount of work per unit time as the loss in the lens goes to zero.

Any realistic point source can only supply a finite amount of energy per unit time, and therefore its amplitude must go to zero. It will be cloaked!

Number of Citations does not establish validity

VOLUME 85, NUMBER 18

PHYSICAL REVIEW LETTERS

30 OCTOBER 2000

Negative Refraction Makes a Perfect Lens

J. B. Pendry

Condensed Matter Theory Group, The Blackett Laboratory, Imperial College, London SW7 2BZ, United Kingdom
(Received 25 April 2000)

10,000 citations but wrong when the source is near the lens



Available online at www.sciencedirect.com



Physica B 394 (2007) 171–175

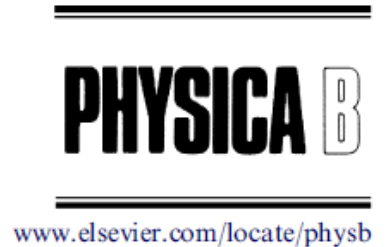

Opaque perfect lenses

Graeme W. Milton^{a,*}, Nicolae-Alexandru P. Nicorovici^b, Ross C. McPhedran^b

11 citations, excluding self-citations and correct

$k_{1eo} = -2, 0.$

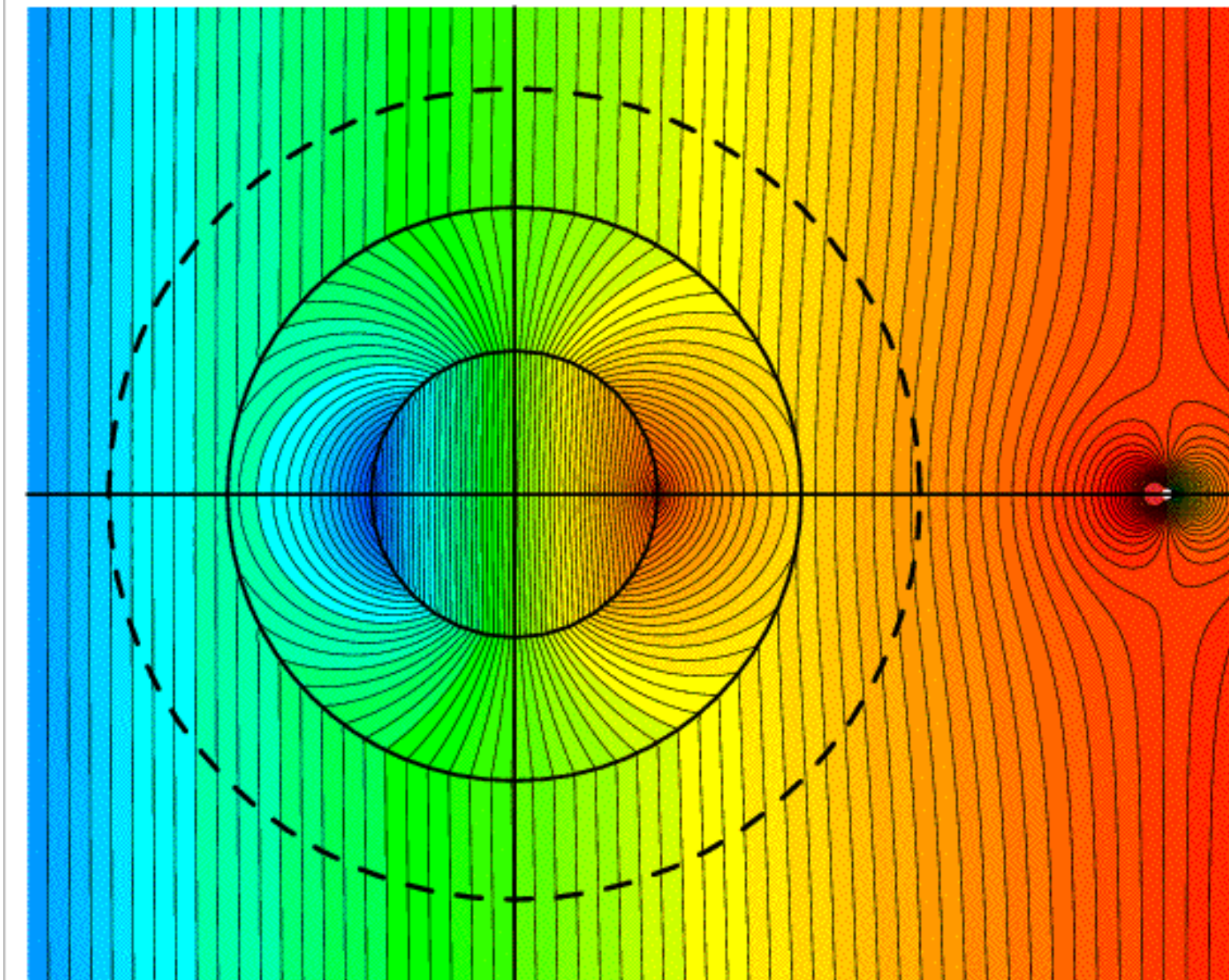

$k_1(e/o) = -0.90585, -0.11345$

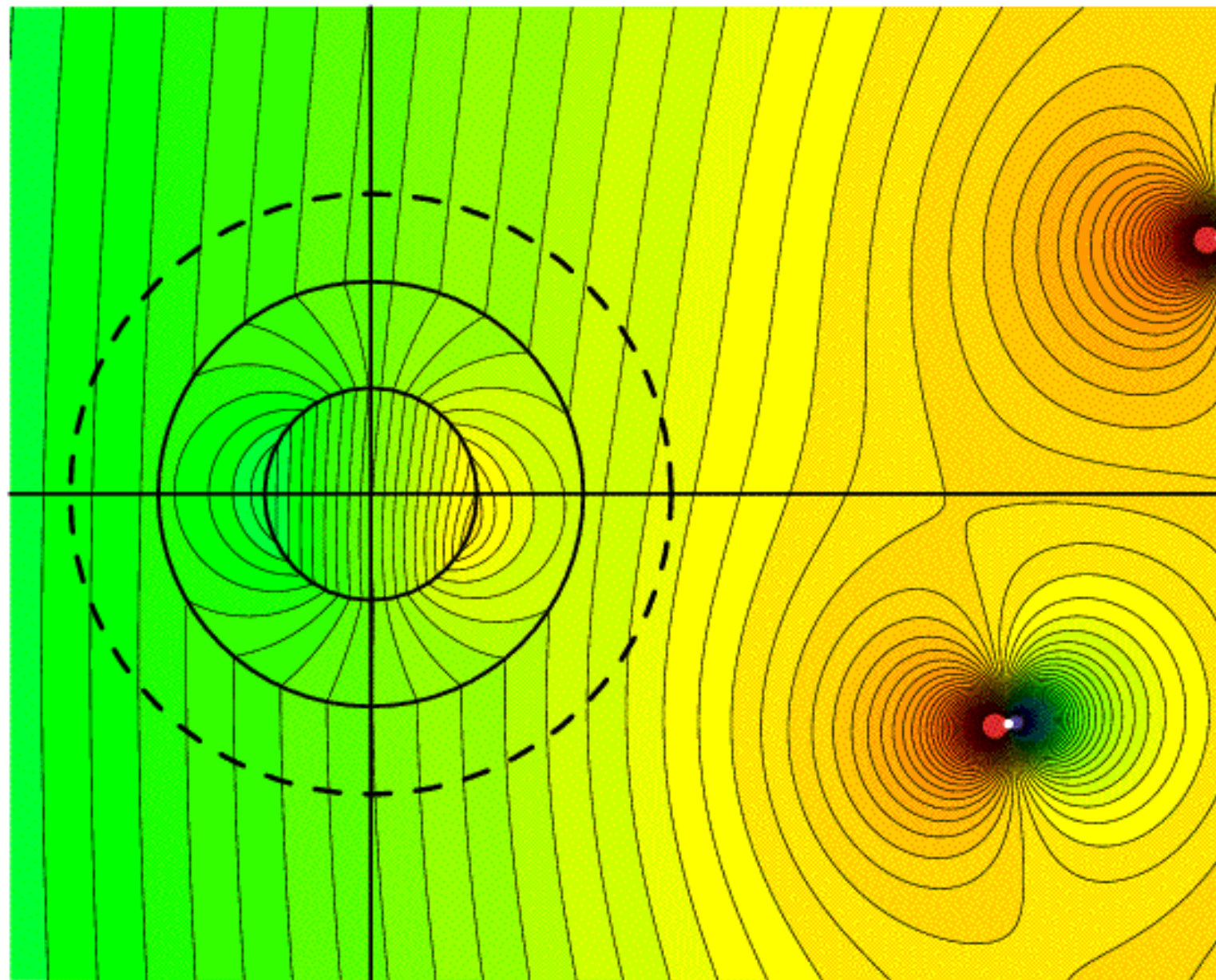

$k_2(e/o) = -0.79466, 0.44939$

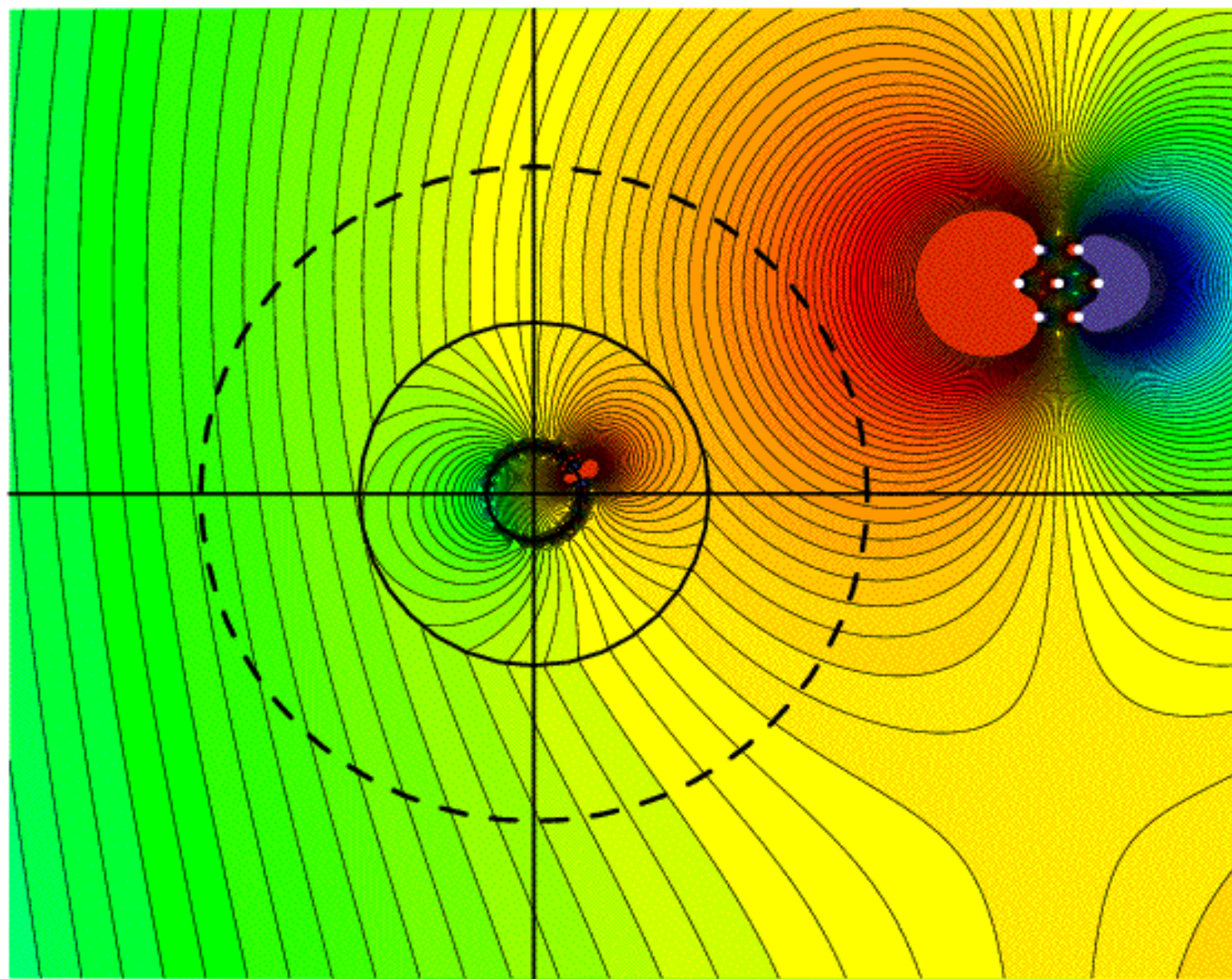

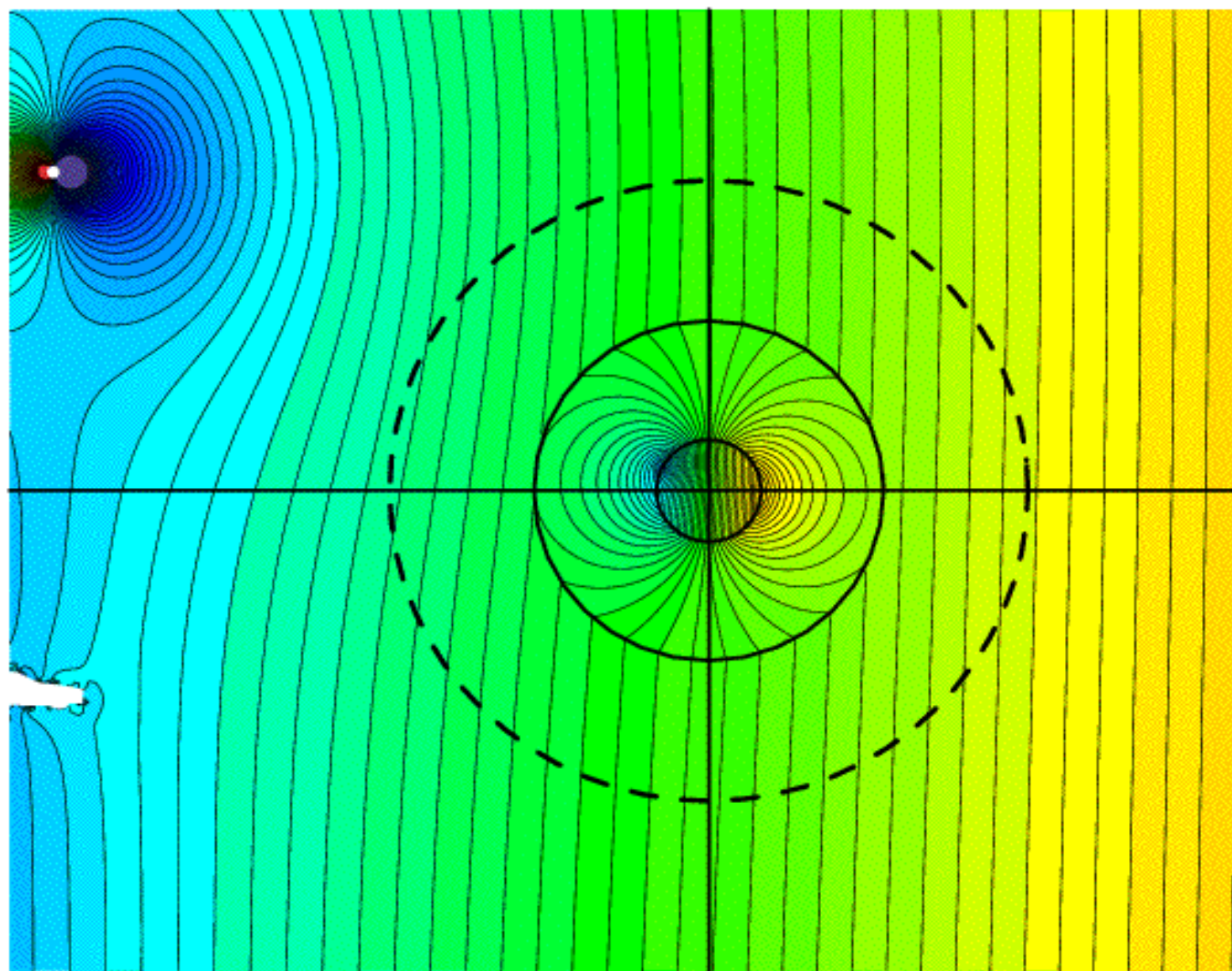

Solutions in folded geometries, and associated cloaking due to anomalous resonance

Graeme W Milton¹, Nicolae-Alexandru P Nicorovici², Ross C McPhedran², Kirill Cherednichenko³ and Zubin Jacob⁴

Published 27 November 2008 • IOP Publishing and Deutsche Physikalische Gesellschaft

New Journal of Physics, Volume 10, November 2008

Focus on Cloaking and Transformation Optics

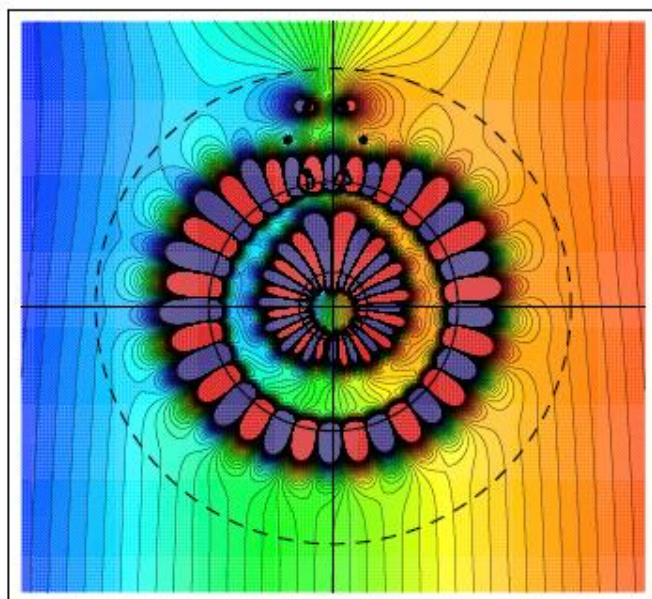

$$\varepsilon_s = -1 + 10^{-9}i$$

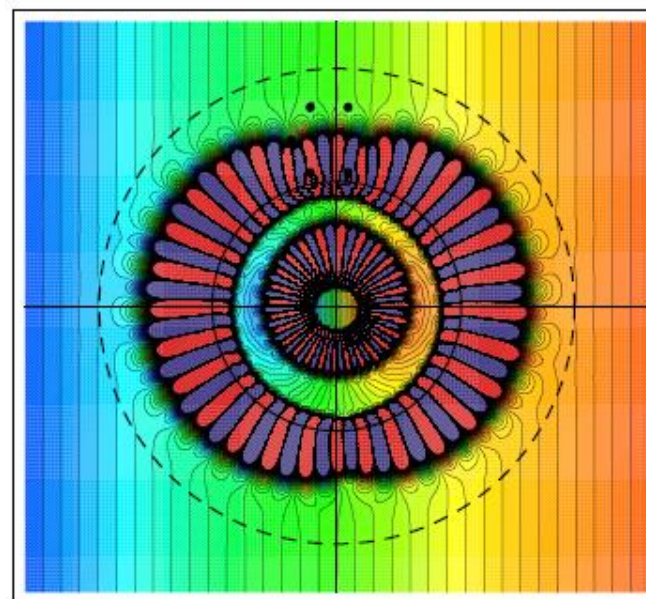

$$\varepsilon_s = -1 + 10^{-15}i$$

Complimentary media cloaking: Lai et. al. (2009)

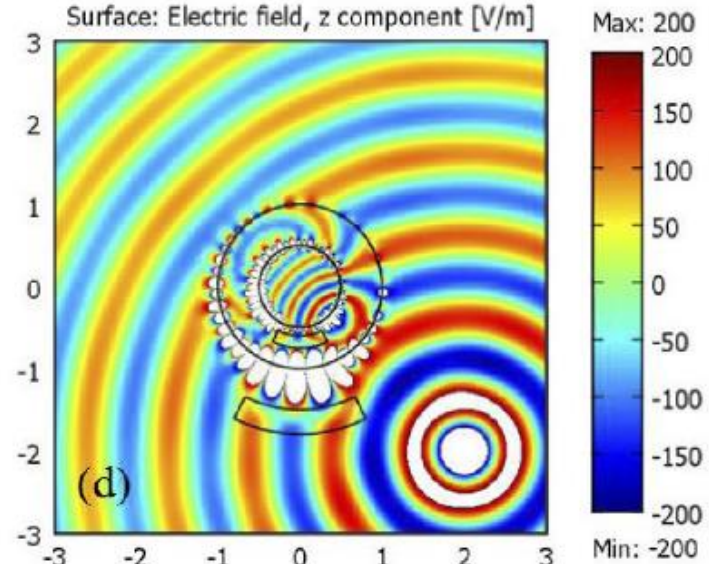
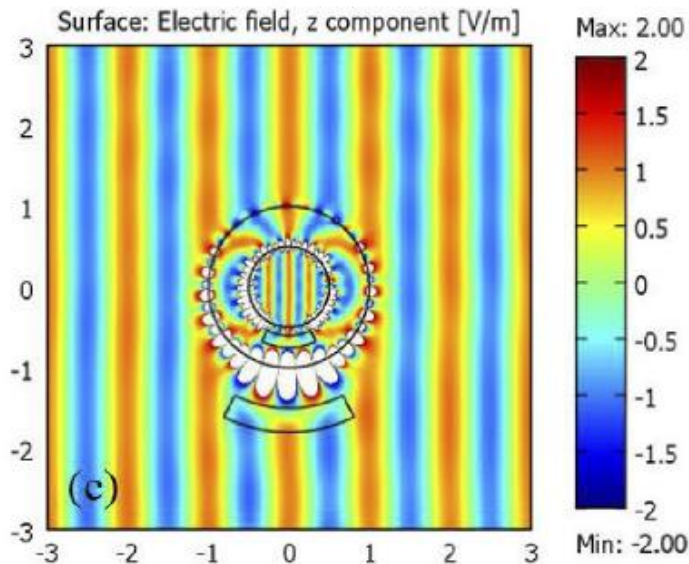
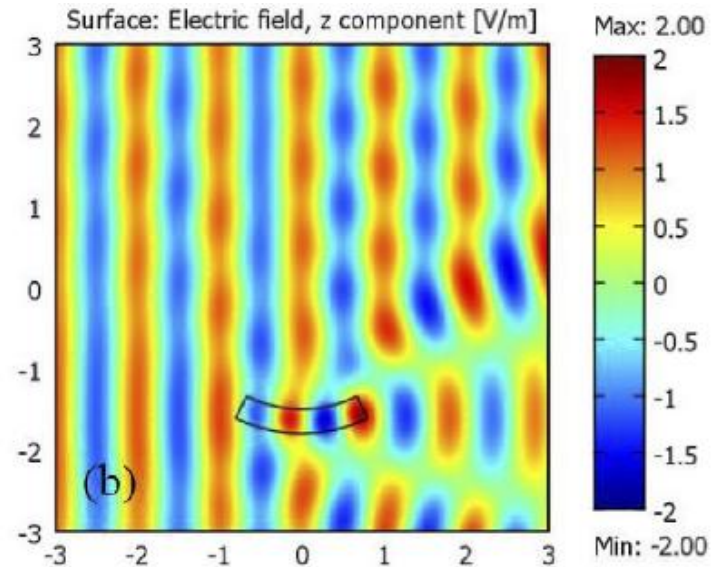
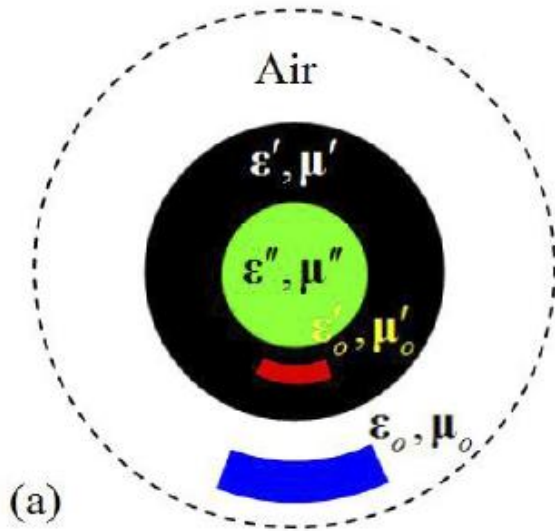

Broadband Active Cloaking

with Fernando Guevara Vasquez
and Daniel Onofrei

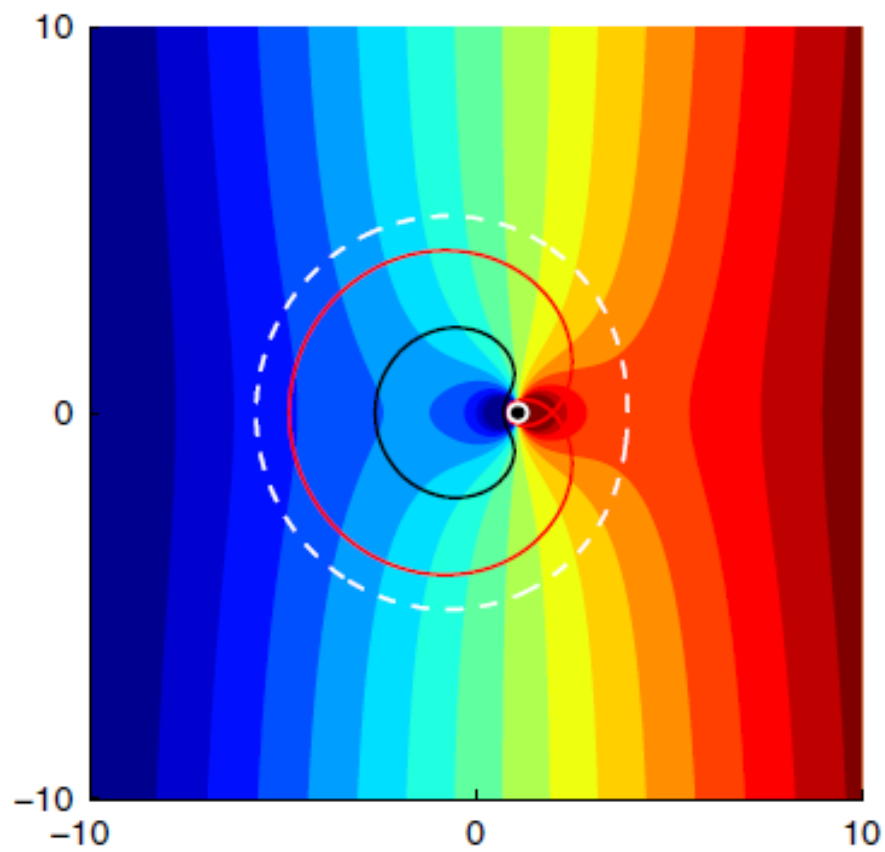

(a)

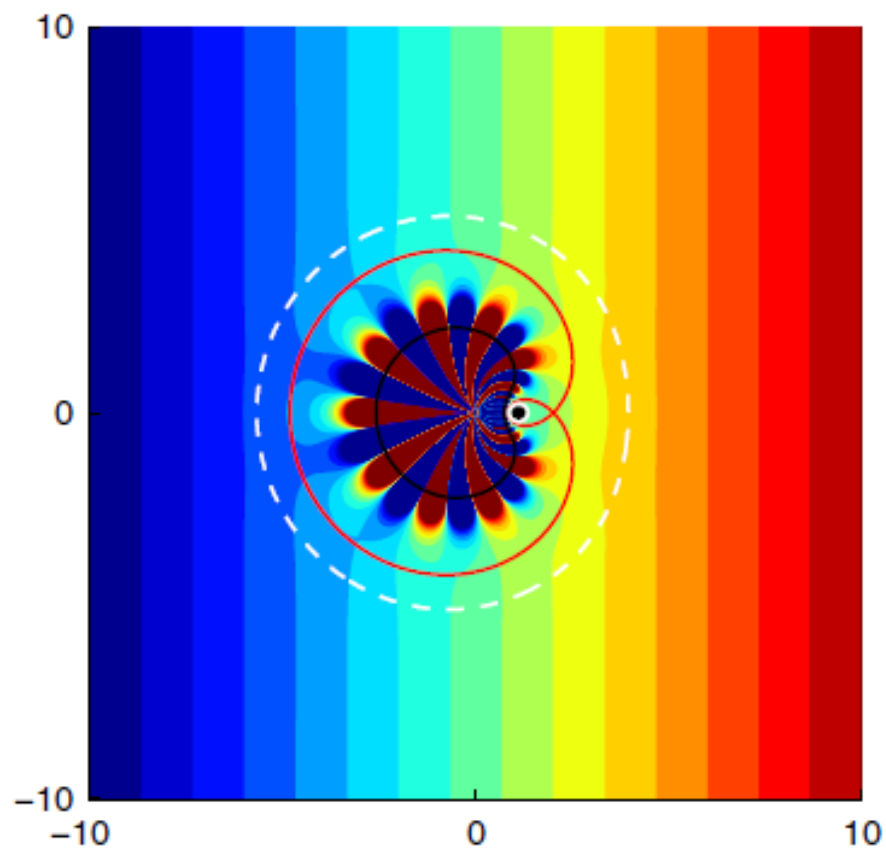

(b)

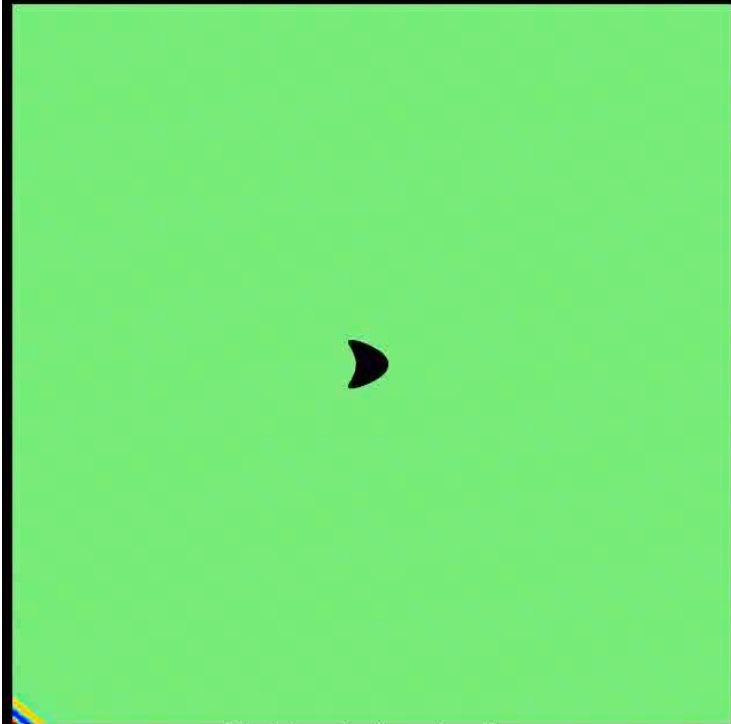

Cloaking devices inactive

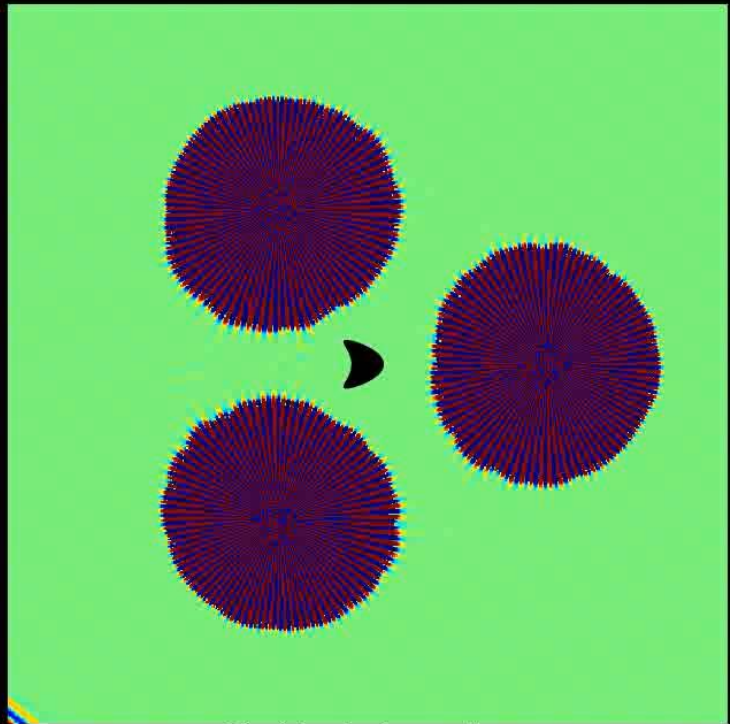

Cloaking devices active

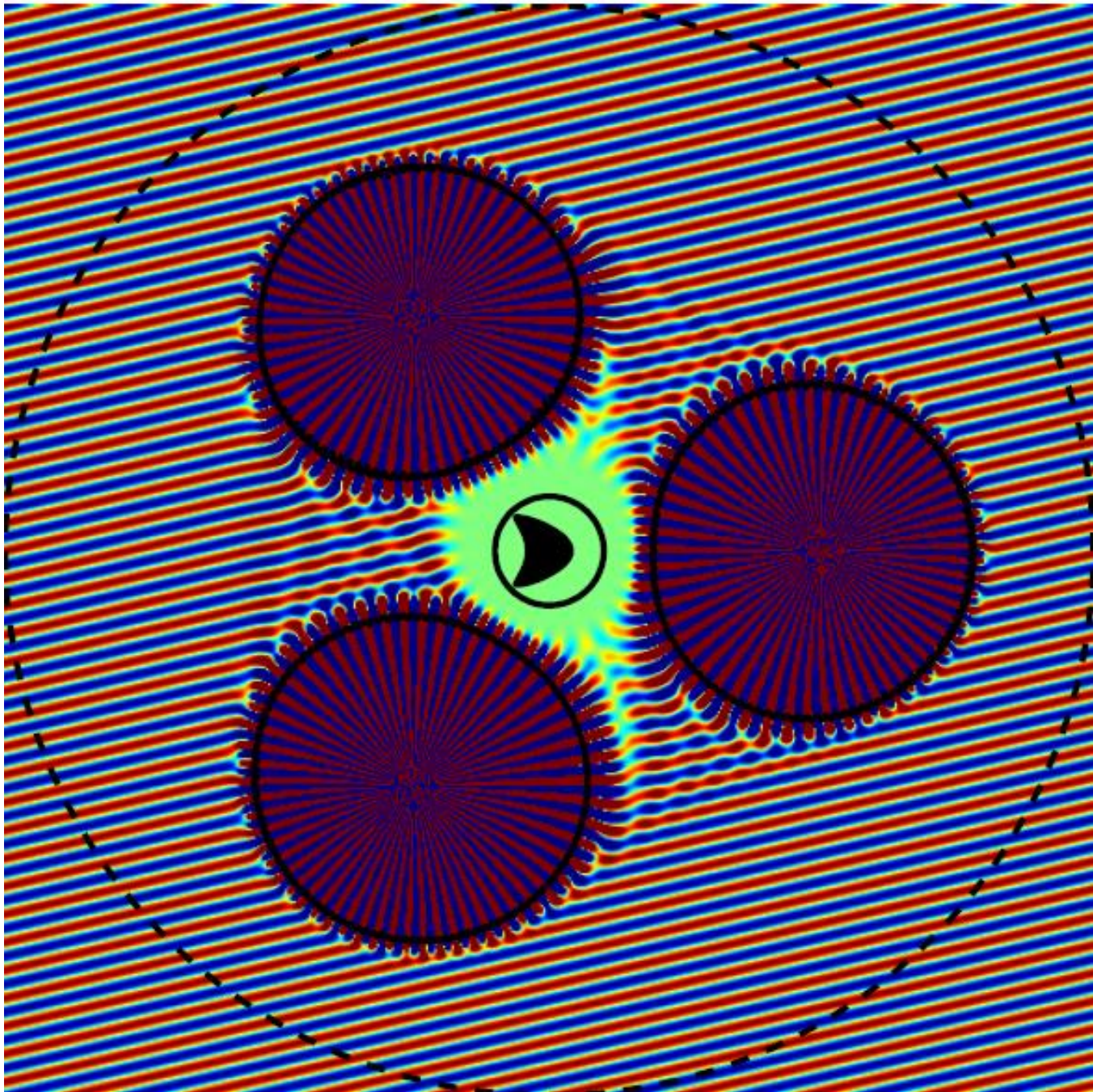

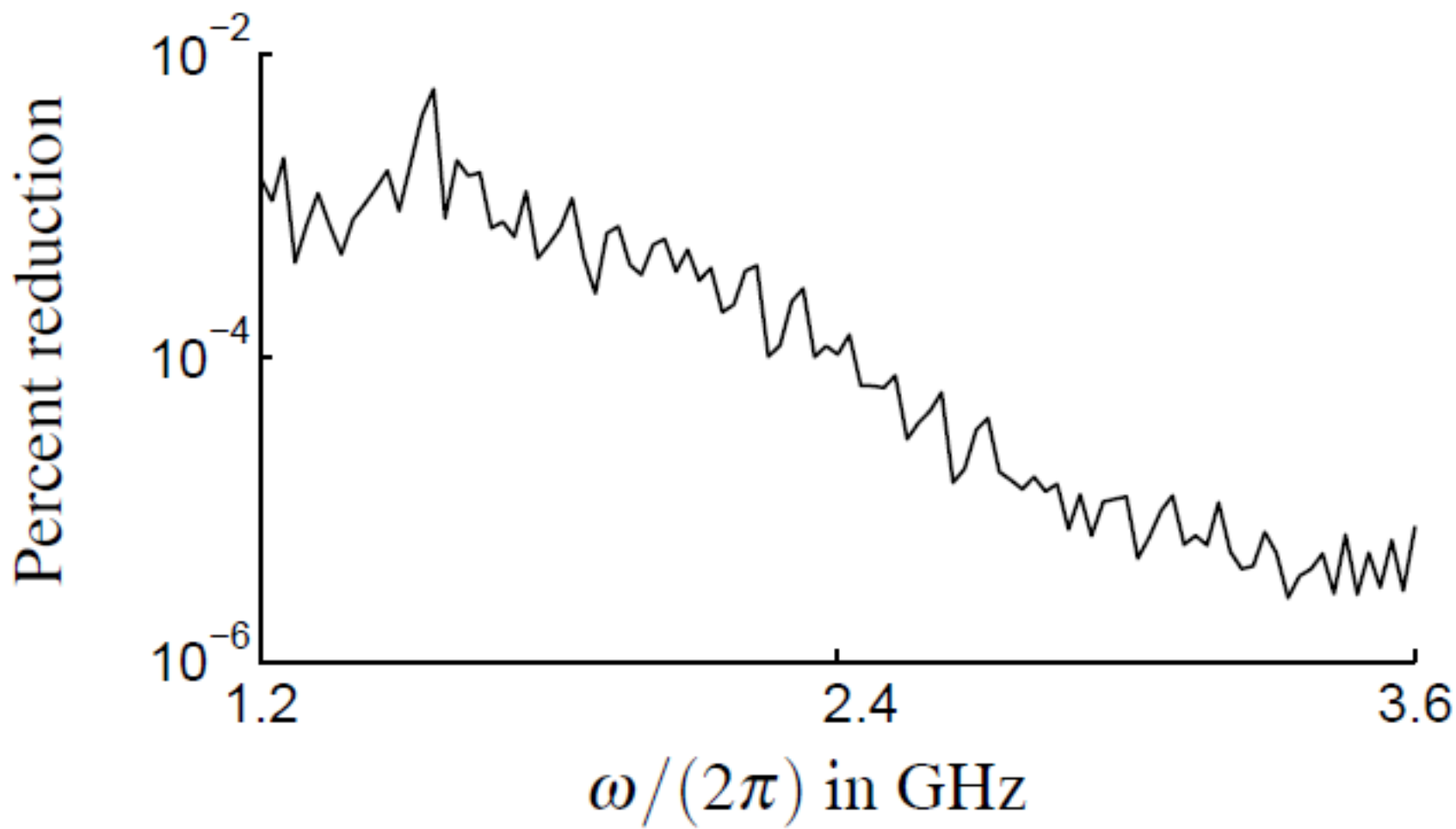

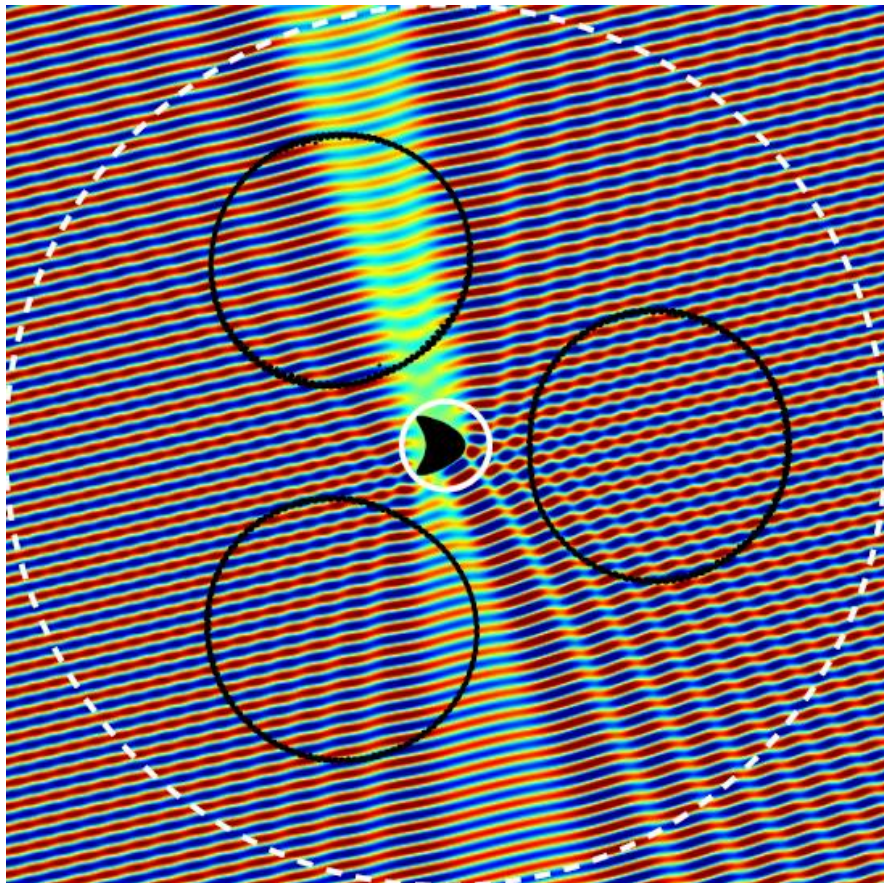

Uncloaked

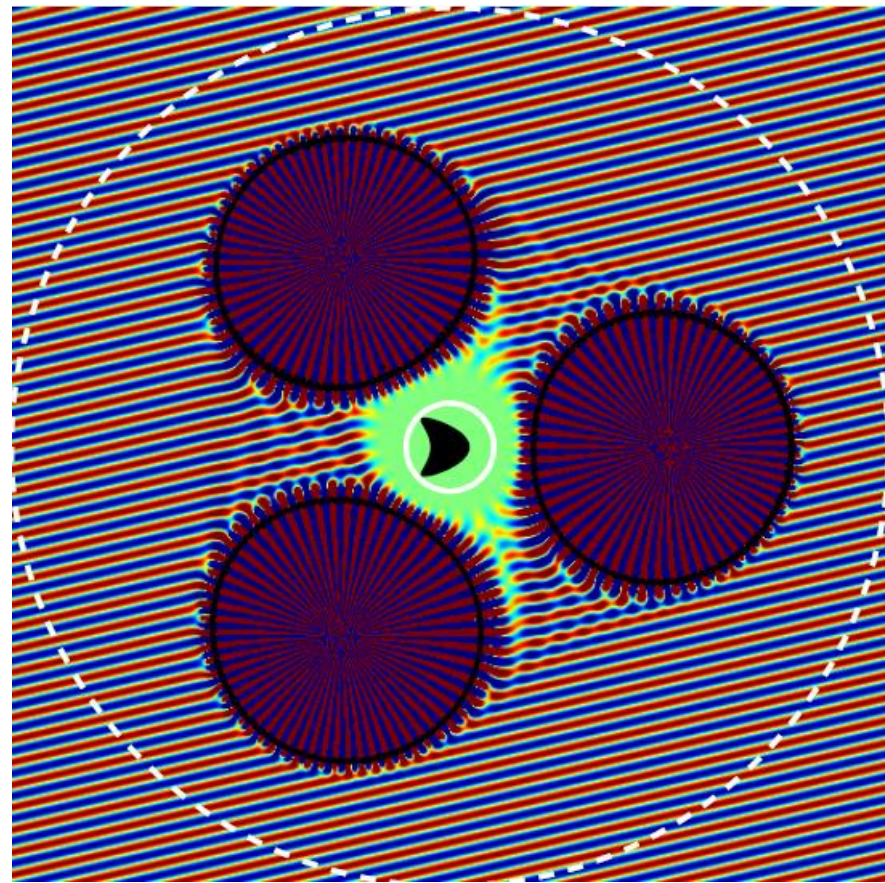

Cloaked

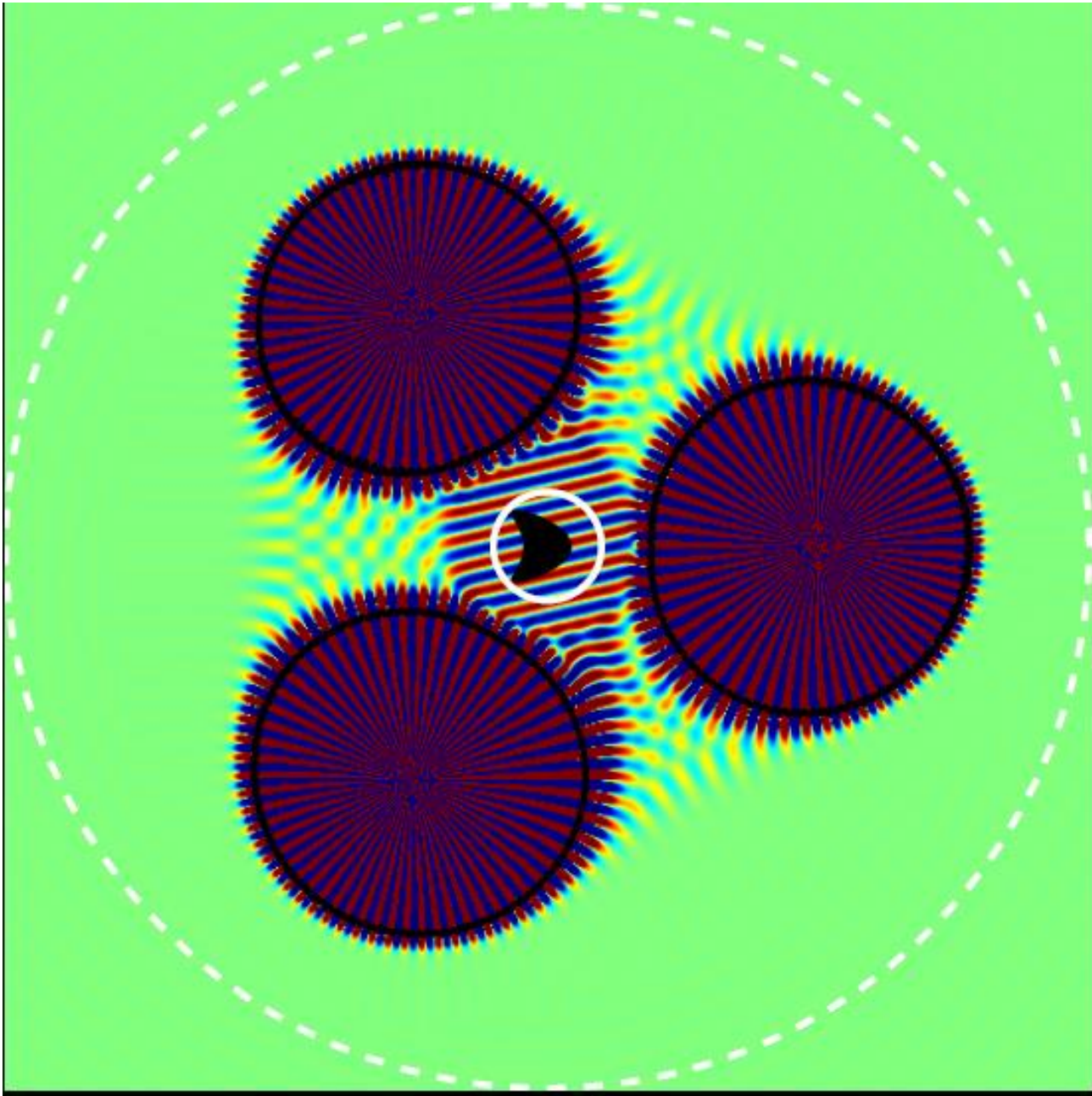

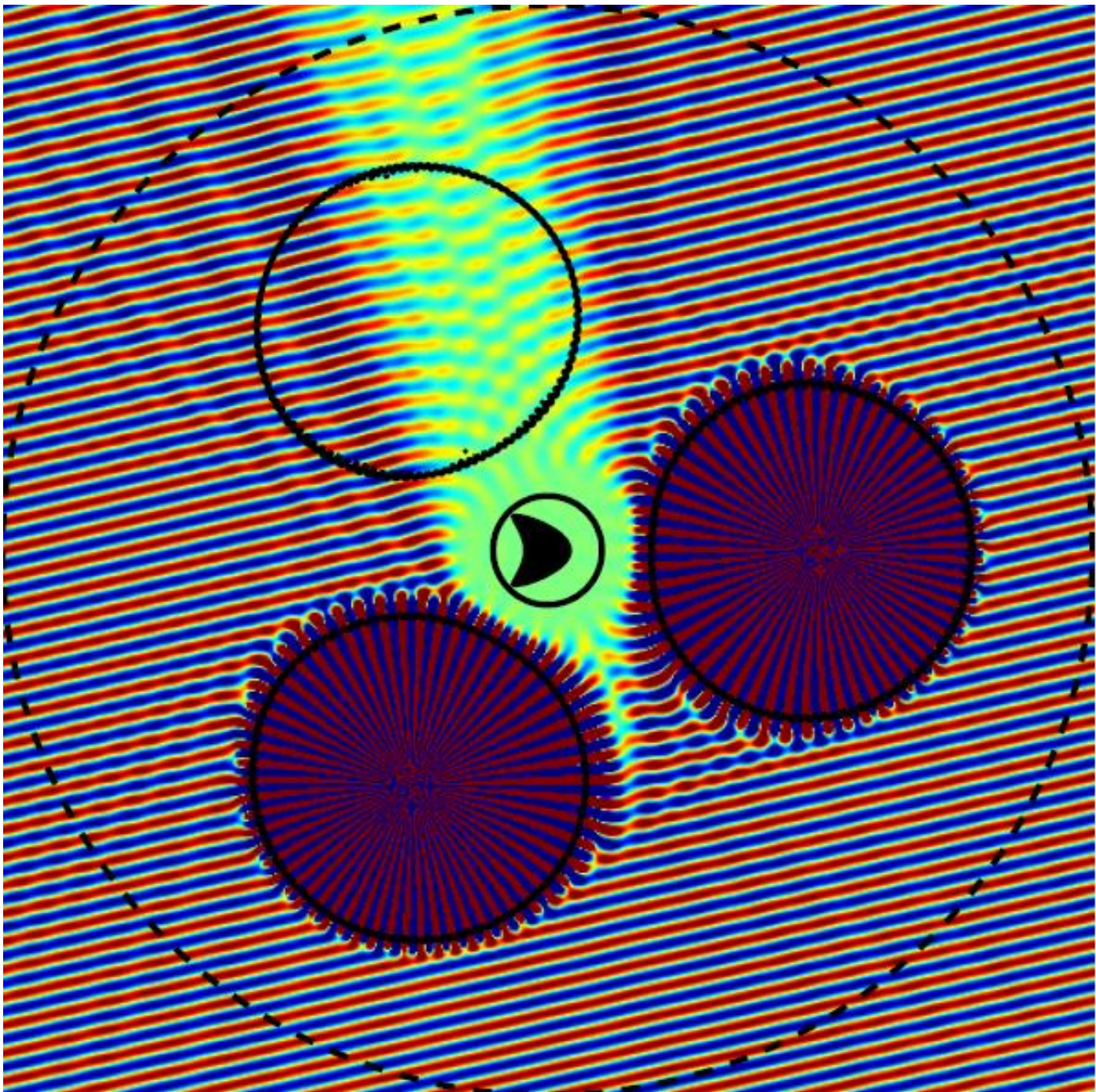

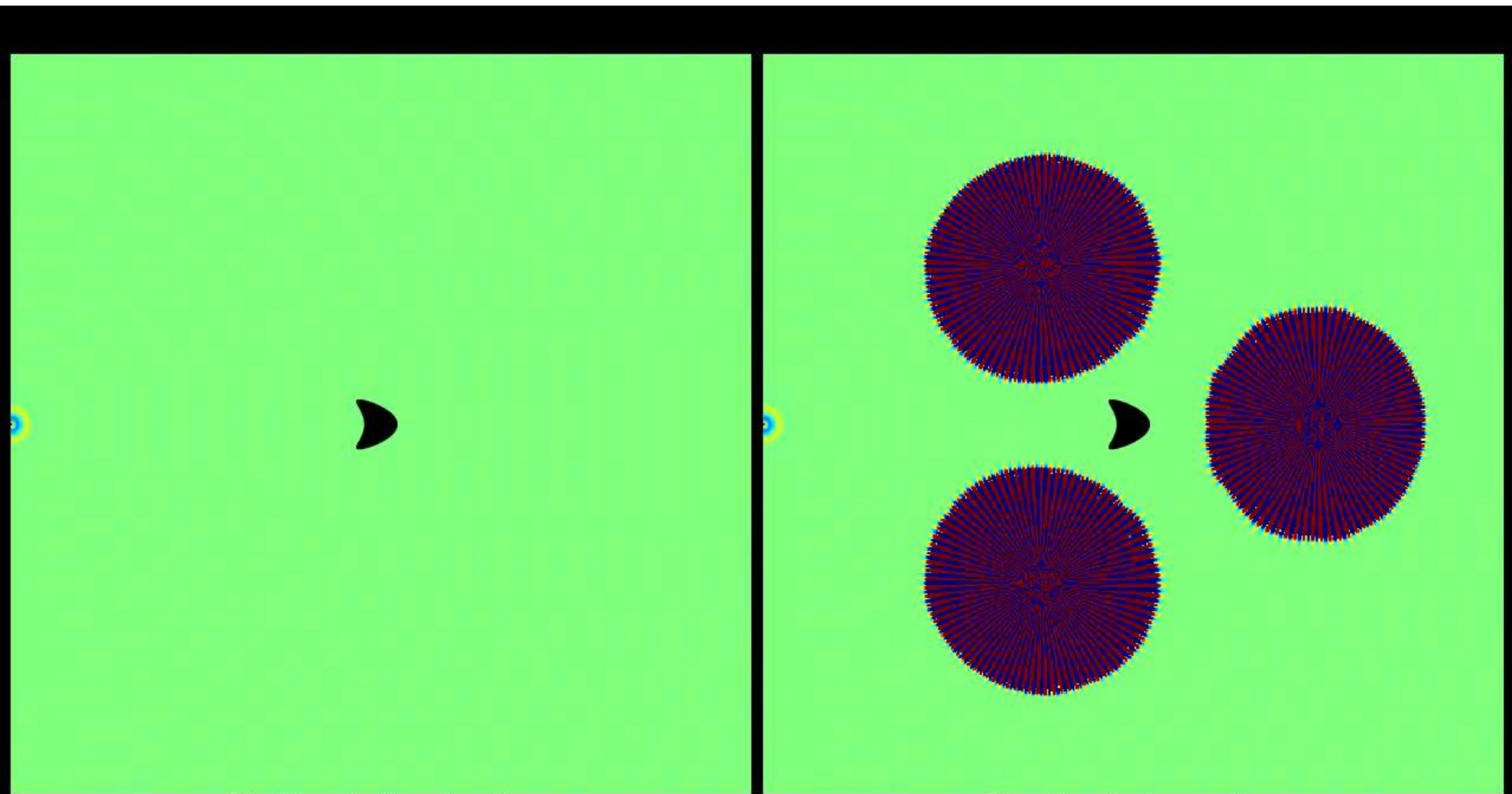

Cloaking devices inactive

Cloaking devices active

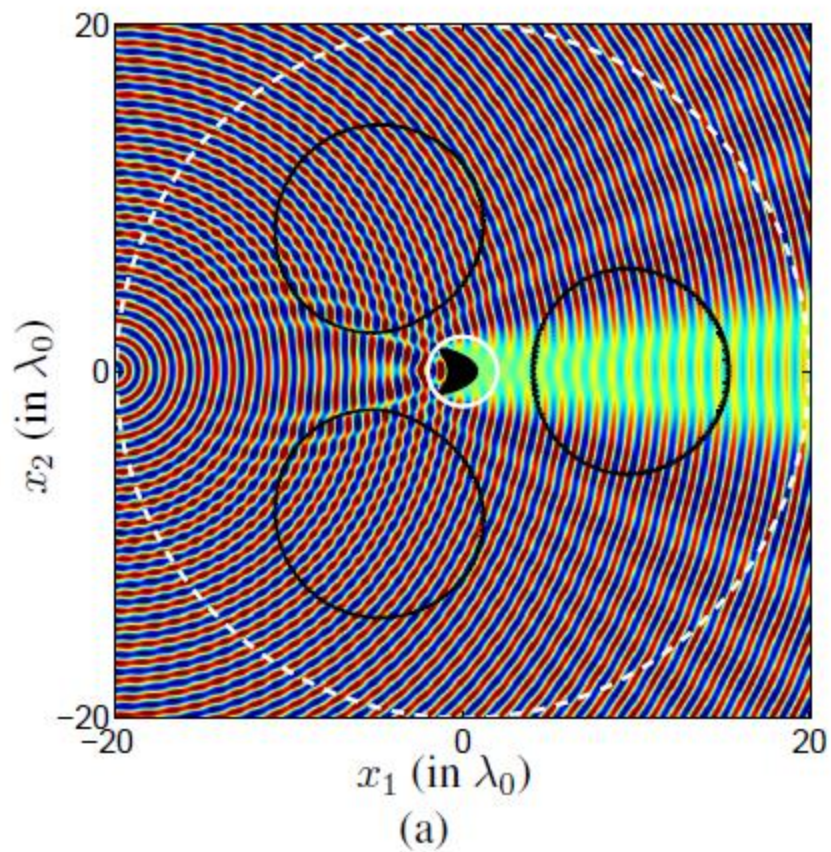

Uncloaked

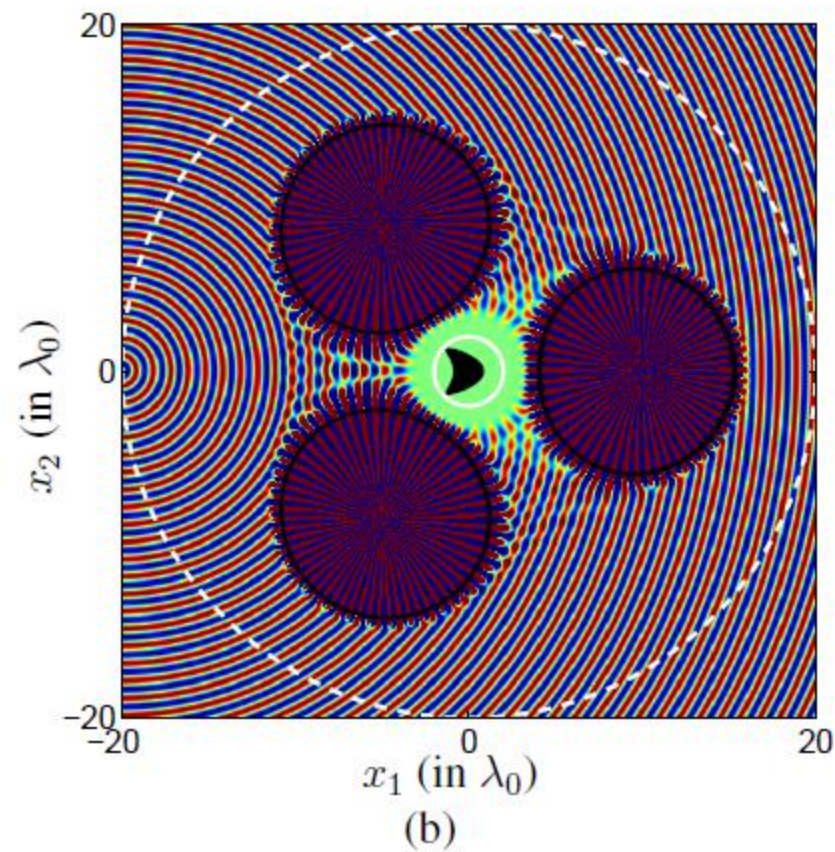

Cloaked

Green's formula cloak of Miller (2006)

$$u_d(\mathbf{x}) = \int_{\partial D} dS_{\mathbf{y}} \left\{ -(\mathbf{n}(\mathbf{y}) \cdot \nabla_{\mathbf{y}} u_i(\mathbf{y})) G(\mathbf{x}, \mathbf{y}) + u_i(\mathbf{y}) \mathbf{n}(\mathbf{y}) \cdot \nabla_{\mathbf{y}} G(\mathbf{x}, \mathbf{y}) \right\},$$

$$G(\mathbf{x}, \mathbf{y}) = \frac{i}{4} H_0^{(1)}(k |\mathbf{x} - \mathbf{y}|)$$

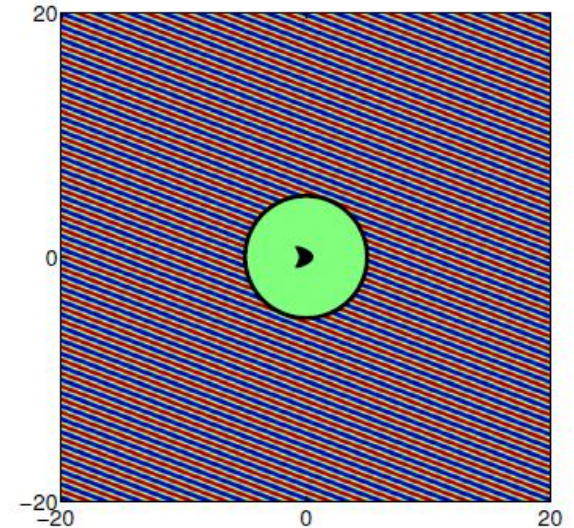
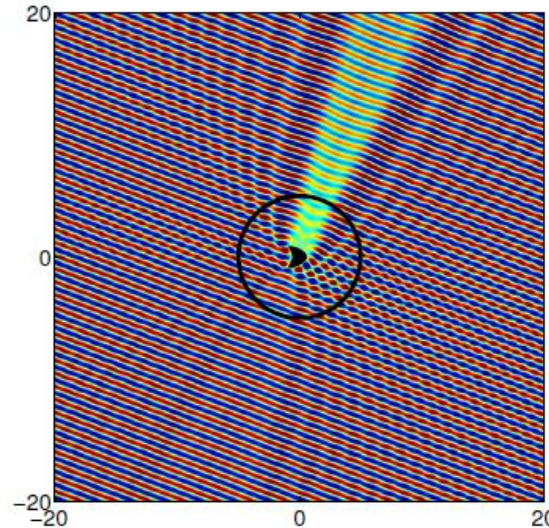
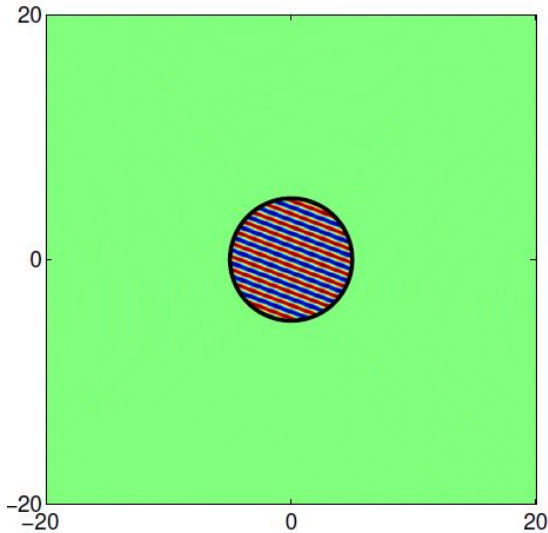

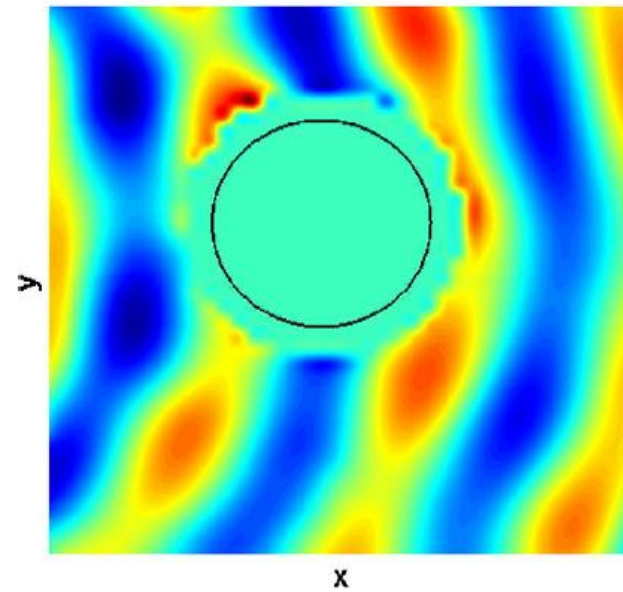
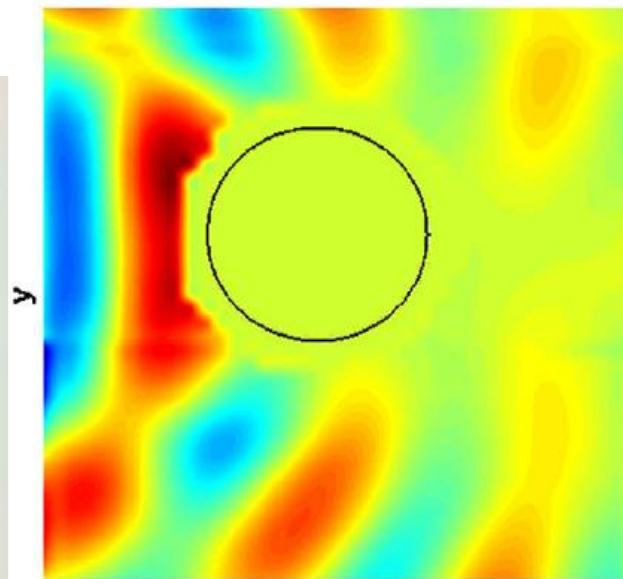

Experimental realization of active cloaking:
Selvanayagam and Eleftheriades (2013)

Use the addition formula:

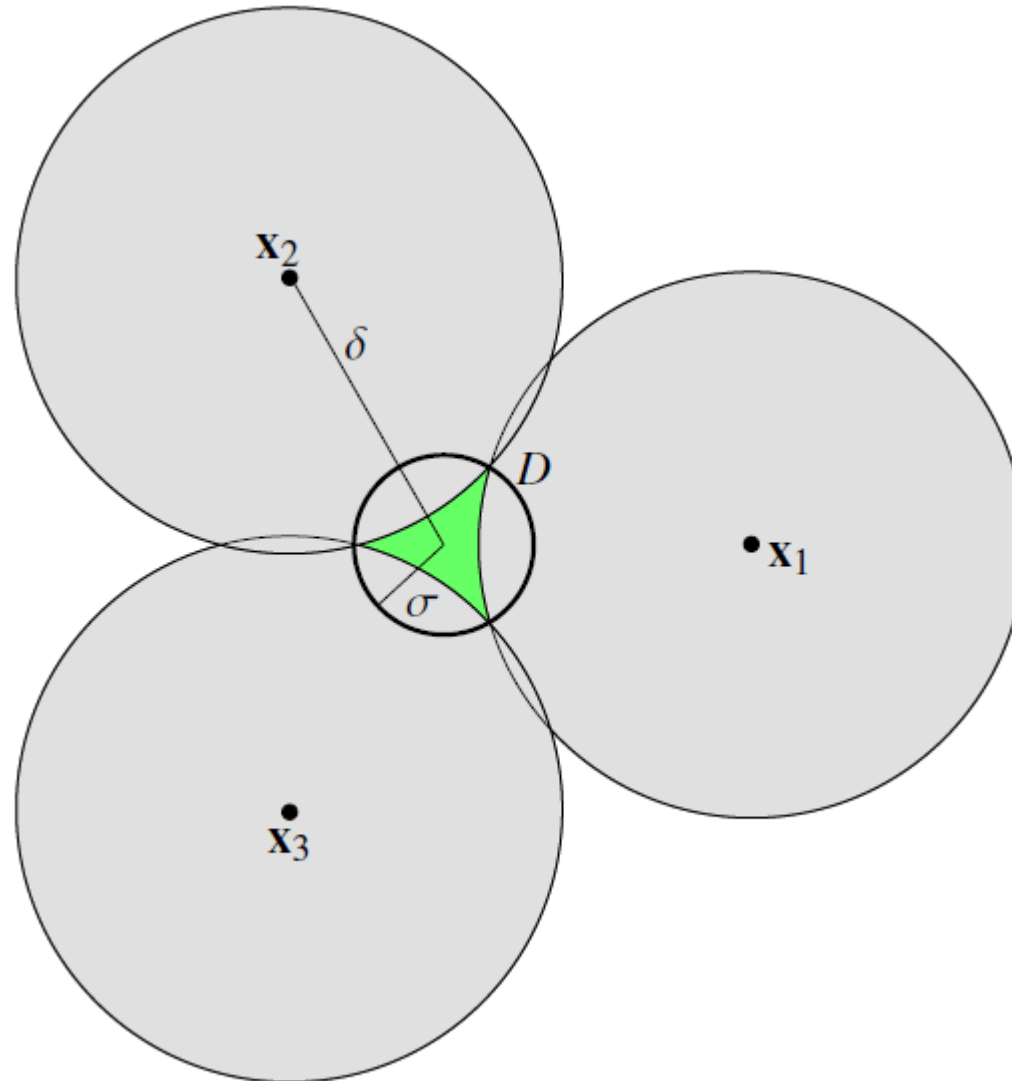

Green's formula

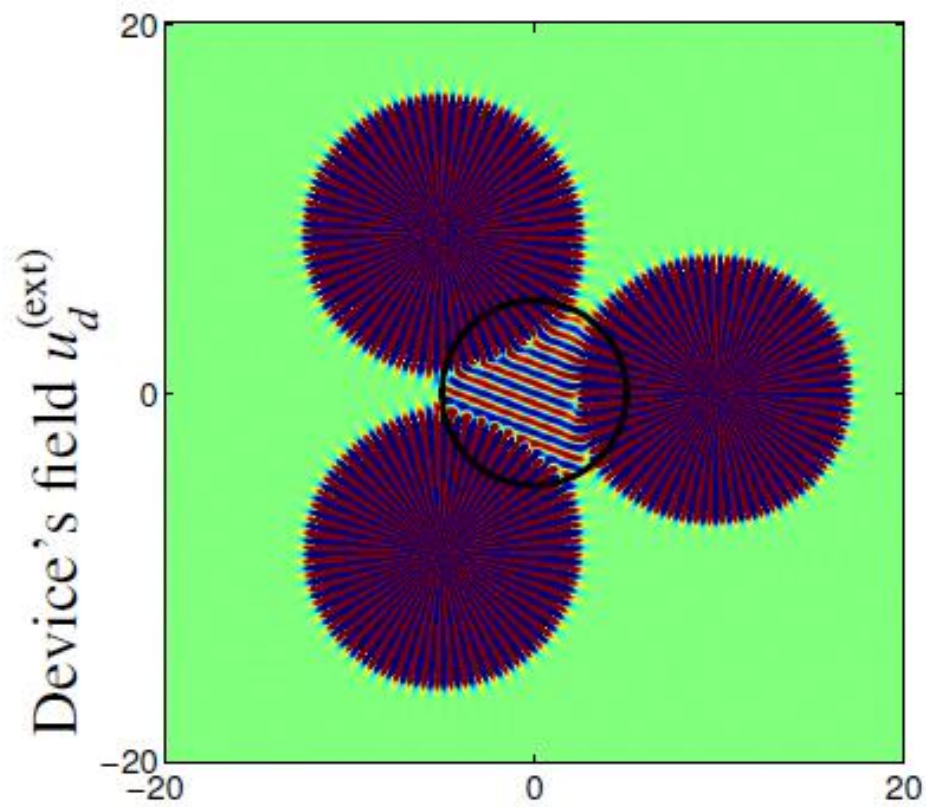

SVD

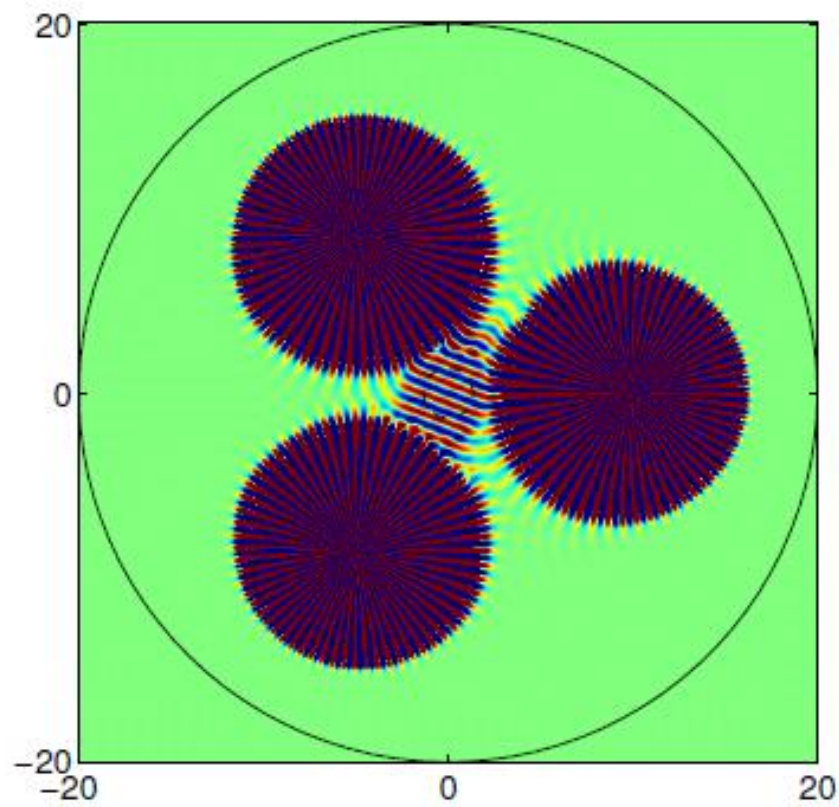

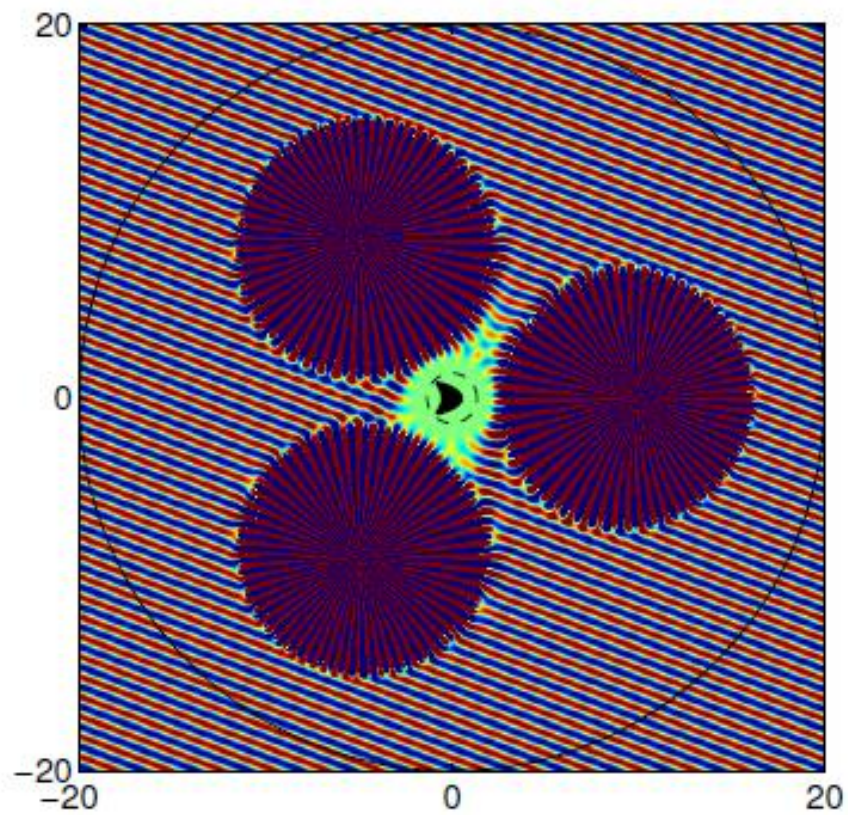
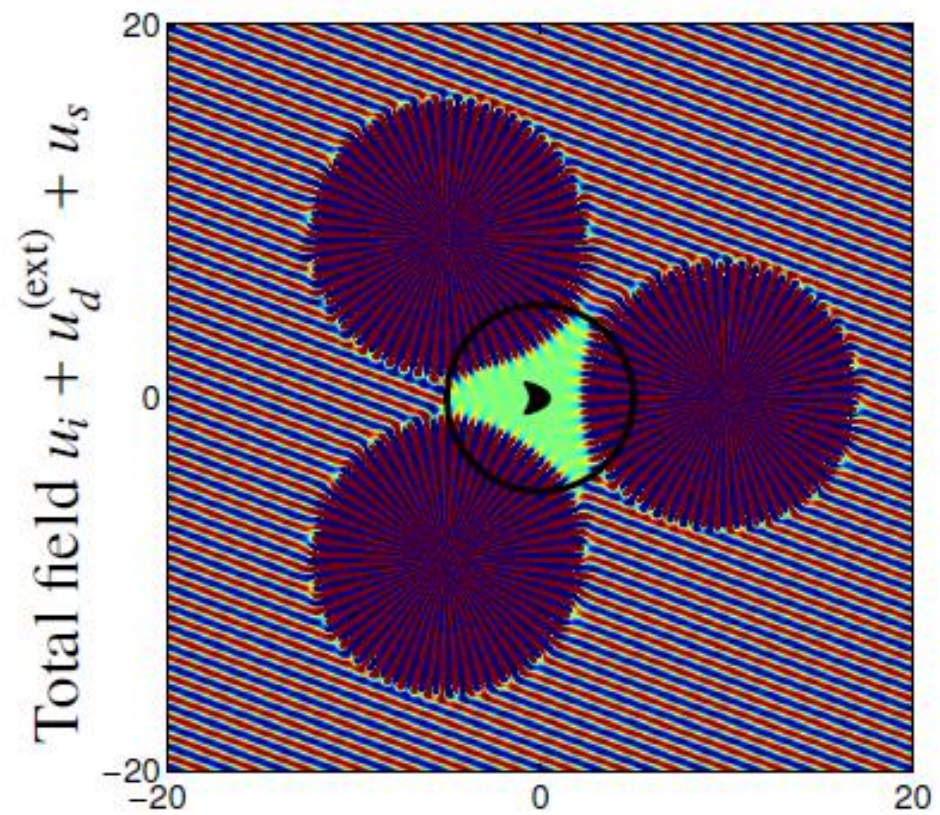

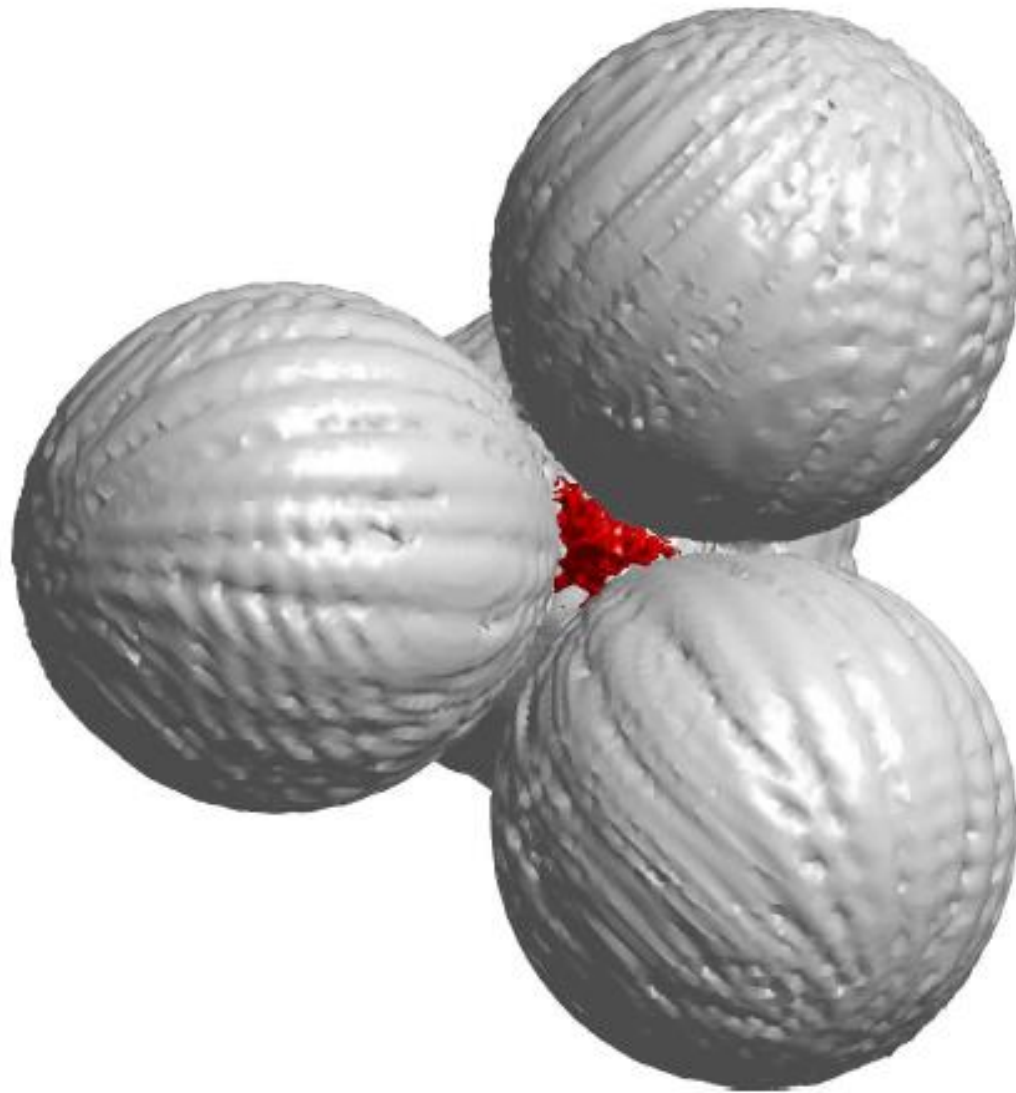

(b) $|u_d| = 5$

Cloaking for 3-dimensional acoustics

Thank you!

Thank you!

Extending the Theory of Composites to Other Areas of Science

Edited By
Graeme W. Milton



Extending the Theory of Composites
to Other Areas of Science

Edited By
Graeme W. Milton

MILTON
&
PATTON
PUBLISHING

Thank you!

Thank you!

Thank you!

Thank you!

Thank you!